



***BID AND CONTRACT DOCUMENTS  
AND SPECIFICATIONS  
FOR***

---

**FORMER TARGET BUILDING DEMOLITION**

---

***RFB # 23-002***

***City of Federal Way  
Public Works Department  
33325 8th Avenue South  
Federal Way, WA 98003***

**BID AND CONTRACT DOCUMENTS AND SPECIFICATIONS  
FOR  
FORMER TARGET BUILDING DEMOLITION**

**RFB # 23-002**

---

Bids Accepted Until 2:00 p.m., January 31, 2023 at  
City of Federal Way  
33325 8th Avenue South  
Federal Way, WA 98003

---

Prepared By:

City of Federal Way  
Engineering Division



---

The contract plans and specifications for this Project have been reviewed and approved by:

 1/13/2023  
Public Works Director / Deputy Public Works Director



# TABLE OF CONTENTS

	<u>PAGE</u>
ADVERTISEMENT FOR BIDS .....	1
INSTRUCTIONS TO BIDDERS & CHECKLISTS .....	2
BID PROPOSAL .....	4
BID BOND.....	8
SUBCONTRACTOR LIST .....	9
CONTRACTOR WAGE LAW COMPLIANCE CERTIFICATION .....	10
PROPOSAL FOR INCORPORATING RECYCLED MATERIALS.....	11
PUBLIC WORKS CONTRACT .....	12
SAMPLE CONTRACT CHANGE ORDER .....	19
CERTIFICATE OF INSURANCE .....	21
PERFORMANCE AND PAYMENT BOND.....	22
CONTRACTOR’S RETAINAGE OPTION .....	24
RETAINAGE BOND TO CITY OF FEDERAL WAY .....	25
 SPECIAL PROVISIONS .....	 SP
APPENDICES	
A—PREVAILING WAGES	
B—EXISTING UTILITY INFORMATION	
C—MISCELLANEOUS APPLICATIONS	
SITE PLANS .....	BOUND SEPARATELY

## **ADVERTISEMENT FOR BIDS** **FORMER TARGET BUILDING DEMOLITION**

**SUBMITTAL OF SEALED BIDS:** Notice is hereby given that the City of Federal Way will receive sealed bids through January 31, 2023, at 2:00 p.m. at the City Hall Finance Department at 33325 8th Avenue South, Federal Way, Washington 98003. Proposals received after said date and time will not be considered. All timely bids will be opened and read publicly aloud in the Hylebos Conference Room inside City Hall, and also via Zoom remote meeting, at 2:05 p.m. on January 31, 2023. The remote meeting can be accessed at [www.zoom.us](http://www.zoom.us) by clicking on "Join a Meeting", or by telephone at (253) 215-8782, and entering Meeting ID: 814 4852 1658 and Passcode: 051224.

This project shall consist of: Demolition and disposal of existing building and foundation, together with decommissioning of existing utilities and removal of parking lot illumination system.

The City anticipates awarding this project to the successful bidder as soon as the Contract and all required documents are executed in full. The City agrees to delay Notice to Proceed until city demolition permit issuance. The Contractor must complete all work within **30 working days** of the Notice to Proceed date.

**BID DOCUMENTS:** Plans, Specifications, Addenda, and plan holders list are available on-line through Builders Exchange of Washington at [www.bxwa.com](http://www.bxwa.com). Click on: "Posted Projects," "Public Works," and "City of Federal Way." It is recommended that Bidders "Register" in order to receive automatic email notification of future addenda and to place themselves on the "Bidders List." Bidders that do not register will need to periodically check on-line for addenda issued on this project. Contact Builders Exchange of Washington at (425) 258-1303 if you require assistance with access or registration. An informational copy of plans, specifications, and addenda are available for viewing only at the City of Federal Way Finance Department.

**QUESTIONS:** Any questions must be directed to Omar Barron, Senior Civil Engineer by email at [omar.barron@cityoffederalway.com](mailto:omar.barron@cityoffederalway.com), or by letter addressed to same. Questions must be received by the City no later than 5:00 p.m. three business days preceding the bid opening to allow a written reply to reach all prospective Bidders before the submission of bids.

**OTHER PROVISIONS:** All bids and this Project shall be governed by the Contract, as defined by the Washington State Department of Transportation Standard Specifications for Road, Bridge, and Municipal Construction 2023 (Standard Specifications), which is incorporated by this reference as though set forth in full.

All bid proposals shall be in accordance with the Contract and all bid proposals shall be accompanied by a bid deposit or bond in the amount required in the Contract. Forfeiture of the proposal bond or deposit to the City shall be in accordance with the Contract.

The City, in accordance with Title VI of the Civil Rights Act of 1964, 78 Stat. 252, 42 U.S.C. 2000d to 2000d-4 and Title 49 C.F.R., Department of Transportation, Subtitle A, Office of the Secretary, Part 21, Nondiscrimination in Federally-assisted programs of the Department of Transportation issued pursuant to such Act, hereby notifies all bidders that it will affirmatively ensure that in any contract entered into pursuant to this advertisement, disadvantaged business enterprises as defined at 49 CFR Part 26 will be afforded full opportunity to submit bids in response to this invitation and will not be discriminated against on the grounds of race, color, national origin, or sex in consideration for an award. The City encourages minority and women-owned firms to submit bids consistent with the City's policy to ensure that such firms are afforded the maximum practicable opportunity to compete for and obtain public contracts.

The City of Federal Way reserves the right to reject any and all bids, waive any informalities or minor irregularities in the bidding, and determine which bid or bidder meets the criteria set forth in the bid documents.

**DATES OF PUBLICATION:**

Daily Journal of Commerce  
Federal Way Mirror

Publish January 13, 2023 and January 20, 2023  
Publish January 13, 2023 and January 20, 2023

**CITY OF FEDERAL WAY**

**FORMER TARGET BUILDING DEMOLITION**

**RFB-1**

**RFB #23-002**

*CFW RFB VERSION 2021-DEC*

## **INSTRUCTIONS TO BIDDERS & CHECKLISTS**

### **(1) ADVERTISEMENT FOR BIDS AND CONTRACT DOCUMENTS**

The Advertisement for Bids and Contract Documents contain bidder instructions that must be complied with.

### **(2) EXAMINATION OF BID AND CONTRACT DOCUMENTS – BIDDER RESPONSIBILITIES**

The submission of a bid shall constitute an acknowledgment upon which the City may rely that the bidder has thoroughly examined and is familiar with the bid and Contract Documents, the Project site, the availability of materials and labor, publically available information, and has reviewed and inspected all applicable federal, state, and local statutes, regulations, ordinances and resolutions dealing with or related to the equipment and/or services to be provided herein. The failure or neglect of a bidder to examine such documents, statutes, regulations, ordinances or resolutions shall in no way relieve the bidder from any obligations with respect to the bidder's bid or the contract documents. No claim for additional compensation will be allowed which is based upon a lack of knowledge of any contract documents, statutes, regulations, ordinances or resolutions. Bidders shall visit delivery and service locations(s) as required. Bidders shall become familiar with and verify any environmental factors, which may impact current or future prices for this requirement.

### **(3) INTERPRETATION OF BID AND CONTRACT DOCUMENTS**

No oral clarifications, interpretations, or representation will be made to any bidder as to the meaning of the bid or Contract Documents. Bidders shall not rely upon any oral statement or conversation they may have with City's employees, agents, representatives, consultants, or design professionals regarding the Contract Documents, whether at the pre-bid meeting or otherwise and no oral communications will be binding upon the City. Any questions must be directed to Omar Barron, Senior Civil Engineer by email at omar.barron@cityoffederalway.com, or by letter addressed to same. The questions must be received by the City no later than 5:00 p.m. three business days preceding the bid opening to allow a written reply to reach all prospective Bidders before the submission of their bids. Any interpretation deemed necessary by the City will be in the form of an Addendum to the bid documents and when issued will be sent as promptly as is practical to all parties to whom the bid documents have been issued. All such Addenda shall become part of the bid.

### **(4) BID PRICE**

The bid price shall include everything necessary for the completion of the Contract and the Work including, but not limited to, furnishing all materials, equipment, tools, freight charges, facilities and all management, superintendence, labor and service, except as may be provided otherwise in the Contract Documents. All Washington State sales tax and all other government taxes, assessments and charges shall be included in the various Bid item prices as required by law. The offer shall remain in effect ninety (90) days after the bid opening.

### **(5) POSTPONEMENT OF BID OPENING**

The City reserves the right to postpone the date and time for the opening of bids by Addendum at any time prior to the bid opening date and time announced in these documents.

### **(6) REJECTION OF BIDS**

The City reserves the right to reject any bid for any reason including, but not limited to, the reasons listed in Special Provisions Section 1-02.13. The City further reserves the right to reject any portion of any bid and/or to reject all bids. In consideration for the City's review and evaluation of its bid, the bidder waives and releases any claims against the City arising from any rejection of any or all bids. If, in the opinion of the City, there is reason to believe that collusion exists among bidders, none of the bids of the participants in such collusion will be considered.

### **(7) RECYCLED PRODUCTS**

The Contractor shall use recycled paper for proposals and for any printed or photocopied material created pursuant to a contract with the City whenever practicable and use both sides of paper sheets for reports submitted to the City whenever practicable.

**(8) BIDDER'S CHECKLIST**

The bidder's attention is especially called to the following forms, which must be executed in full as required. Failure to comply may result in rejection of any bid not so complying.

- Bid Proposal:** The Bid Proposal shall be completed and fully executed, including filling in the total bid amount.
- Bid Bond:** This form is to be executed by the bidder (and the surety company as appropriate, depending upon the option selected by the bidder).
- Subcontractor List:** The Subcontractor List shall be filled in by the bidder.
- Contractor Certification – Wage Law Compliance:** This form shall be filled in and fully executed by the bidder.
- Proposal for Incorporating Recycled Materials:** This form shall be filled in and executed by the bidder.

**(9) CONTRACT CHECKLIST**

The following documents are to be executed and delivered to the City after the Bid is awarded:

- Public Works Contract:** The successful bidder will fully execute and deliver to the City the Public Works Contract ("Contract") from these Bid Documents.
- Certificate of Insurance:** The successful bidder will provide a Certificate of Insurance evidencing the insurance requirement set forth in the Contract.
- Performance/Payment Bond:** The successful bidder will provide a fully executed Performance/Payment Bond as appropriate.
- Contractor's Retainage Option:** The successful bidder will fully execute and deliver to the City the Contractor's Retainage Option.
- Contractor's Retainage Bond:** If the retainage bond option is chosen, then the successful bidder will fully execute and deliver to the City the Contractor's Retainage Bond.
- Business License:** The successful bidder will provide a copy of a current Business License with the City of Federal Way.

**BID PROPOSAL**  
**FORMER TARGET BUILDING DEMOLITION**

**PROPOSAL SUBMITTED TO:**

City of Federal Way  
33325 8th Ave South  
Federal Way, Washington 98003-6325

**PROPOSAL SUBMITTED BY:**

Bidder: \_\_\_\_\_  
*Full Legal Name of Firm*

Contact: \_\_\_\_\_  
*Individual with Legal Authority to sign Bid and Contract*

Address: \_\_\_\_\_  
*Street Address*

\_\_\_\_\_  
*City, State Zip*

Phone: \_\_\_\_\_

E-Mail: \_\_\_\_\_

- Select One of the Following:
- Corporation
  - Partnership.
  - Individual
  - Other

State Contractor's License No.: \_\_\_\_\_

State Contractor's License Expiration Date: \_\_\_\_\_ / \_\_\_\_\_ / \_\_\_\_\_  
*Month Day Year*

State UBI No.: \_\_\_\_\_

State Worker's Comp. Account No.: \_\_\_\_\_

NOTE: All entries shall be written in ink or typed. Unit prices for all items, all extensions, and total amount of bid shall be shown. Enter unit prices in numerical figures only, in dollars and cents to two (2) decimal places (including for whole dollar amounts). All figures must be clearly legible. Bids with illegible figures in the unit price column will be regarded as nonresponsive. Where conflict occurs between the unit price and the total amount specified for any item, the unit price shall prevail, and totals shall be corrected to conform thereto. The Bidder shall complete this entire Bid Form or this bid may be considered non-responsive. The City may correct obvious mathematical errors. The City of Federal Way reserves the right to reject any and all bids, waive any informalities or minor irregularities in the bidding, and determine which bid or bidder meets the criteria set forth in the bid documents.

<b>FORMER TARGET BUILDING DEMOLITION</b> All unit prices shall NOT include applicable sales tax. Sales tax should be applied to the subtotal for this bid schedule.						
Item No.	Spec. Div.	Bid Item Description	Unit	Plan Qty	Unit Price	Amount
1	1-10	MOBILIZATION	LS	1	\$	\$
2	1-04	MINOR CHANGE	FA	1	\$25,000.00	\$25,000.00
3	2-02	REMOVAL OF STRUCTURES AND OBSTRUCTIONS	LS	1	\$	\$
4	2-02	REMOVING EXISTING ILLUMINATION	LS	1	\$	\$
5	7-08	PLUGGING EXISTING PIPE	EA	1	\$	\$
6	7-15	REMOVE SERVICE CONNECTION	EA	3	\$	\$
7	8-01	EROSION/WATER POLLUTION CONTROL	LS	1	\$	\$
<b>SUBTOTAL</b>						\$
<b>SALES TAX (10.1%)</b>						\$
<b>TOTAL</b>						\$

The documents incorporated by reference, as if fully set forth, are the Advertisement for Bids, the Instructions to Bidders and Checklists, the Contractor's Bid Proposal (including all forms and supplemental information listed on the Bidders Checklist), the Contract Documents (including Project Plans, Specifications, and all Appendices, Amendments, and Supplemental Reports & Information), the Contract Provisions (including all forms and supplemental information listed on the Contract Checklist), the version of the Washington State Standard Specifications for Road, Bridge, and Municipal Construction identified herein, and any other documents provided to bidders and/or referenced in or referred to by the Contract Documents.

Pursuant to and in compliance with the Advertisement for Bids for the Project, and other documents relating thereto, the undersigned has carefully examined all of the bid and contract documents, considered conditions which may affect the delivery, supply and maintenance for the Project, and hereby proposes to furnish all labor, materials and perform all work as required in strict accordance with the contract documents, for the referenced bid amount, inclusive of Washington State sales tax and all other government taxes, assessments and charges as required by law.



**NON-COLLUSION AFFIDAVIT**

By signing this proposal, the undersigned acknowledges that the person(s), firm, association, or corporation has (have) not, either directly or indirectly, entered into any agreement, participated in any collusion, or otherwise taken any action in restraint of free competitive bidding in connection with this project.

To report rigging activities, call 1-800-424-9071. The U.S. Department of Transportation (USDOT) operates the toll-free hotline Monday through Friday, 8:00 a.m. to 5:00 p.m., Eastern Time. Anyone with knowledge of possible bid rigging, bidder collusion, or other fraudulent activities should use the hotline to report such activities. The hotline is part of USDOT's continuing effort to identify and investigate highway construction contract fraud and abuse and is operated under the direction of the USDOT Inspector General. All information will be treated confidentially and caller anonymity will be respected.

**CONFLICTS OF INTEREST, GRATUITIES, & NON-COMPETITIVE PRACTICES**

By signing this proposal, the undersigned agrees as follows:

- (1) That it has no direct or indirect pecuniary or proprietary interest, that it shall not acquire any interest which conflicts in any manner or degree with the work, services, equipment or materials required to be performed and/or provided under this contract and that it shall not employ any person or agent having any such interests. In the event that the Contractor or its agents, employees or representatives hereafter acquires such a conflict of interest, it shall immediately disclose such interest to the City and take action immediately to eliminate the conflict or to withdraw from this contract, as the City may require; and
- (2) That no person or selling agency except bona fide employees or designated agents or representatives of the Contractor have been employed or retained to solicit or secure this contract with an agreement or understanding that a commission, percentage, brokerage, or contingent fee would be paid; and
- (3) That no gratuities in the form of entertainment, gifts or otherwise, were offered or given by the Contractor or any of its agents, employees or representatives, to any official, member or employee of the City or other governmental agency with a view toward securing this contract or securing favorable treatment with respect to the awarding or amending, or the making of any determination with respect to the performance of this contract.

**AFFIDAVIT OF ELIGIBILITY**

The Contractor certifies that it is properly licensed and registered under the laws of the State of Washington and has not been determined to have been in violation of RCW 50.12.070(1)(b), RCW 51.16.070(1)(b), or RCW 82.32.070(2) within the last two years. The Contractor further certifies that it has not been determined, within the last one year, to have committed any combination of two of the following violations or infractions within a five year period: (1) Violated RCW 51.48.020(1) or 51.48.103; or (2) Committed an infraction or violation under Chapter 18.27 RCW.

**CERTIFICATION OF LAWFUL EMPLOYMENT**

The Contractor hereby certifies that it has complied with all provisions of the Immigration and Nationality Act now or as herein after amended, 8 U.S.C. 1101 et. Seq., and that all employees, including subcontractor employees, are lawfully permitted to perform work in the United States as provided in this agreement with the City of Federal Way.

Receipt of the following Addendums is hereby acknowledged:

Addendum No. \_\_\_\_ Date Issued: \_\_\_\_\_

Addendum No. \_\_\_\_ Date Issued: \_\_\_\_\_

Addendum No. \_\_\_\_ Date Issued: \_\_\_\_\_

The undersigned individual represents and warrants that he or she is dully authorized to execute the bid and all bid documents on behalf of any partnership, joint venture or corporation.

By: \_\_\_\_\_  
*Signature*

\_\_\_\_\_  
*Printed Name*

\_\_\_\_\_  
*Title*

Subscribed and sworn to before me this \_\_\_\_ day of \_\_\_\_\_, 20\_\_.

\_\_\_\_\_  
*Signature of Notary*

\_\_\_\_\_  
*Printed name of Notary*  
*Notary Public in and for the State of Washington*  
*My commission expires: \_\_\_\_\_*



# SUBCONTRACTOR LIST



## Subcontractor List

*Prepared in compliance with RCW 39.30.060 as amended*

### To Be Submitted with the Bid Proposal

Project Name \_\_\_\_\_

**Failure to list subcontractors with whom the bidder, if awarded the contract, will directly subcontract for performance of the work of structural steel installation, rebar installation, heating, ventilation and air conditioning, plumbing, as described in Chapter 18.106 RCW, and electrical, as described in Chapter 19.28 RCW or naming more than one subcontractor to perform the same work will result in your bid being non-responsive and therefore void.**

Subcontractor(s) with whom the bidder will directly subcontract that are proposed to perform the work of structural steel installation, rebar installation, heating, ventilation and air conditioning, plumbing, as described in Chapter 18.106 RCW, and electrical as described in Chapter 19.28 RCW must be listed below. The work to be performed is to be listed below the subcontractor(s) name.

**To the extent the Project includes one or more categories of work referenced in RCW 39.30.060, and no subcontractor is listed below to perform such work, the bidder certifies that the work will either (i) be performed by the bidder itself, or (ii) be performed by a lower tier subcontractor who will not contract directly with the bidder.**

Subcontractor Name \_\_\_\_\_

Work to be performed \_\_\_\_\_

Subcontractor Name \_\_\_\_\_

Work to be performed \_\_\_\_\_

Subcontractor Name \_\_\_\_\_

Work to be performed \_\_\_\_\_

Subcontractor Name \_\_\_\_\_

Work to be performed \_\_\_\_\_

Subcontractor Name \_\_\_\_\_

Work to be performed \_\_\_\_\_

\* Bidder's are notified that it is the opinion of the enforcement agency that PVC or metal conduit, junction boxes, etc, are considered electrical equipment and therefore considered part of electrical work, even if the installation is for future use and no wiring or electrical current is connected during the project.

DOT Form 271-015  
Revised 06/2020

# **CONTRACTOR WAGE LAW COMPLIANCE CERTIFICATION**

**FAILURE TO RETURN THIS CERTIFICATION AS PART OF THE BID PROPOSAL PACKAGE WILL MAKE THIS BID NONRESPONSIVE AND INELIGIBLE FOR AWARD.**

I hereby certify, under penalty of perjury under the laws of the State of Washington, on behalf of the firm identified below that, to the best of my knowledge and belief, this firm has **NOT** been determined by a final and binding citation and notice of assessment issued by the Washington State Department of Labor and Industries or through a civil judgment entered by a court of limited or general jurisdiction to have willfully violated, as defined in RCW 49.48.082, any provision of Chapters 49.46, 49.48, and 49.52 RCW within three (3) years prior to the date of the Request for Bids.

Bidder Name: \_\_\_\_\_  
*Print Full Legal Name of Firm*

By: \_\_\_\_\_  
*Signature of Authorized Person*

\_\_\_\_\_  
*Print Name of Person Making Certifications for Firm*

Title: \_\_\_\_\_  
*Title of Person Signing Certificate*

Place: \_\_\_\_\_  
*Print City and State Where Signed*

Date: \_\_\_\_\_

# PROPOSAL FOR INCORPORATING RECYCLED MATERIALS



APWA-WA Division 1 Committee

rev. 1/8/2016

---

---

## **Proposal for Incorporating Recycled Materials into the Project**

In compliance with a new law that went into effect January 1, 2016 (SHB1695), the Bidder shall propose below, the total percent of construction aggregate and concrete materials to be incorporated into the Project that are recycled materials. Calculated percentages must be within the amounts allowed in Section 9-03.21(1)E, Table on Maximum Allowable Percent (By Weight) of Recycled Material, of the Standard Specifications.

Proposed total percentage: \_\_\_\_\_ percent.

*Note: Use of recycled materials is highly encouraged within the limits shown above, but does not constitute a Bidder Preference, and will not affect the determination of award, unless two or more lowest responsive Bid totals are exactly equal, in which case proposed recycling percentages will be used as a tie-breaker, per the APWA GSP in Section 1-03.1 of the Special Provisions. Regardless, the Bidder's stated proposed percentages will become a goal the Contractor should do its best to accomplish. Bidders will be required to report on recycled materials actually incorporated into the Project, in accordance with the APWA GSP in Section 1-06.6 of the Special Provisions.*

Bidder: \_\_\_\_\_

Signature of Authorized Official: \_\_\_\_\_

Date: \_\_\_\_\_

---

---

# **PUBLIC WORKS CONTRACT**

THIS PUBLIC WORKS CONTRACT ("Contract") is dated effective this \_\_\_\_ day of \_\_\_\_\_, 20\_\_ and is made by and between the City of Federal Way, a Washington municipal corporation ("City or Owner"), and \_\_\_\_\_, a \_\_\_\_\_ ("Contractor"), for the project known as Former Target Building Demolition (the "Project").

A. The City desires to retain an independent contractor to furnish all labor and materials necessary to perform work necessary to complete the Project; and

B. The Contractor has the requisite skill and experience to perform such work.

NOW, THEREFORE, the parties ("Parties") agree to the following terms and conditions:

## **1. SERVICES BY CONTRACTOR**

Contractor shall perform all Work and furnish all tools, materials, supplies, equipment, labor and other items incidental thereto necessary for the construction and completion of the Project. Contractor shall perform the Work in a manner consistent with accepted practices for other properly licensed contractors and in accordance with and as described in the Contract Documents, which Work shall be completed to the City's satisfaction, within the time period prescribed by the City and pursuant to the direction of the Mayor or his or her designee.

## **2. TERM**

2.1 This Contract shall commence on the effective date of this Contract and continue until the Project is formally accepted as complete by the City Council, Notice of Project Completion is filed with State agencies, and all bonds for the Project are released by the City.

2.2 The Contractor must complete the Work in accordance with the number of Working Days for the Project as identified in the Contract Documents. With regard to obtaining Substantial Completion and the Completion Date by the Contractor, time is of the essence. In the event the Work is not substantially completed within the time specified in the Contract Documents, Contractor agrees to pay to the City liquidated damages in the amount set forth in the Contract Documents. The parties acknowledge that delays inconvenience the public and cost taxpayers undue sums of money, adding time needed for administration, inspection, and supervision of the Project and diverting City resources from other projects and obligations.

2.3 If the Contractor is unreasonably delayed by others, notification shall be made in writing to the Engineer in accordance with the Contract Documents. Any request for a time extension or additional compensation (including expectancy or consequential damages) allegedly resulting from such delay shall be made in accordance with the procedures of the Contract Documents. Failure to follow the notice procedures in the Contract Documents is a full and complete waiver of Contractor's right to additional time, money, damages, or other relief (including expectancy or consequential damages) as a result of the event or condition giving rise to such request.

## **3. COMPENSATION**

3.1 In consideration of the Contractor performing the Work, the City agrees to pay the Contractor an amount not to exceed \_\_\_\_\_ and \_\_\_\_/100 Dollars (\$ \_\_\_\_\_), which amount shall constitute full and complete payment by the City ("Total Compensation"). The Contractor shall be solely responsible for the payment of any taxes imposed by any lawful jurisdiction as a result of the performance and payment of this Contract.

3.2 The City shall pay the Contractor for Work performed under this Contract as detailed in the Bid Proposal, which is incorporated herein and made a part hereof by this reference, and as detailed in the Contract Documents. The City shall have the right to withhold payment to the Contractor for any of the Work not completed in a satisfactory manner, in the City's sole and absolute discretion, which shall be withheld until such time as Contractor modifies or repairs the Work so that the Work is acceptable to the City. Payment to the Contractor for partial estimates, final estimates, and retained percentages shall be subject to controlling laws.

3.3 In addition to the requirements set forth in the Contract Documents, the Contractor shall maintain Project cost records by cost codes and shall contemporaneously segregate and separately record, at the time incurred, all costs (1) directly associated with each work activity, (2) directly or indirectly resulting from any event, occurrence, condition, or direction for which Contractor seeks an adjustment in Contract price Contract time, or related to any other Claim or protest. Any work performed for which Contractor intends to seek an adjustment in Contract Price or Contract Time, or related to any other Claim or protest, shall be recorded on the same day the work is performed and kept separate so as to distinguish it from Contract Work.

#### **4. INDEPENDENT CONTRACTOR**

4.1 It is the intention and understanding of the Parties that the Contractor shall be an independent contractor and that the City shall be neither liable nor obligated to pay Contractor sick leave, vacation pay or any other benefit of employment, nor to pay any social security or other tax which may arise as an incident of employment. The Contractor shall not conduct itself as nor claim to be an officer or employee of the City. The Contractor shall pay all income and other taxes due. Industrial or any other insurance that is purchased for the benefit of the City, regardless of whether such may provide a secondary or incidental benefit to the Contractor, shall not be deemed to convert this Agreement to an employment contract. It is recognized that Contractor may or will be performing professional services during the Term for other parties; provided, however, that such performance of other services shall not conflict with or interfere with Contractor's ability to perform the Services. Contractor agrees to resolve any such conflicts of interest in favor of the City. Nothing contained in this Contract shall create a contractual or direct relationship with or a cause of action in favor of a Subcontractor or third party against the City, or by the Contractor against the Engineer, or against any of their agents, employees, engineers, or consultants.

4.2 If the Contractor is a sole proprietorship or if this is a contract with an individual, the contractor agrees to notify the City and complete any required form if the Contractor retired under a State of Washington retirement system and agrees to indemnify any losses the City may sustain through the Contractor's failure to do so.

#### **5. INDEMNIFICATION**

##### **5.1 Contractor Indemnification.**

5.1.1 The Contractor shall indemnify, defend, and hold the City, its elected officials, officers, employees, agents, consultants, and volunteers (collectively "the Indemnified Parties") harmless from any costs or losses, and pay and damages or judgments, related to any claim brought by any person employed in any capacity by the Contractor or subcontractor or supplier (of any tier) performing the Work, with respect to the payment of wages, salaries, or other compensation or benefits including but not limited to benefits such as medical, health, retirement, vacation, sick leave, etc.

5.1.2. To the fullest extent permitted by law, the Contractor shall defend, release, indemnify, and hold harmless the City and the Indemnified Parties for, from, and against any and all claims, demands, losses, costs, damages, suits, actions, expenses, fines, penalties, response costs, and liabilities (including costs and all attorney and expert fees and internal personnel costs of investigation) of whatsoever kind or nature to the extent arising from, resulting from, connected with, or incident to the Contractor's performance or failure to perform this Contract or the Work or its breach of this Contract; provided, however, that if the provisions of RCW 4.24.155 apply to the Work and any injuries to persons or property arising out of the performance of this Contract are caused by or result from the concurrent negligence of the Contractor or its subcontractors, agents, employees, or anyone for whom they are legally liable, and an Indemnified Party, the indemnification and defense obligations under this Section 5.1.2 apply only to the extent of the negligence of the Contractor, its subcontractors, agents, employees, and anyone for whom they are legally liable.

5.1.3 Contractor specifically assumes potential liability for actions brought by the Contractor's own employees or former employees against any Indemnified Party, and for that purpose Contractor waives any immunity that may be granted to it under the Washington State Industrial Insurance Act, Title 51 RCW. Contractor's indemnification shall not be limited in any way by any limitation on the amount of damages, compensation or benefits payable to or by any third party under workers' compensation acts, disability benefit acts or any other benefits acts or programs. Provided, however, the Contractor's waiver of immunity by the



provisions of this paragraph extends only to claims against the Contractor by any Indemnified party, and does not include, or extend to, any claims by the Contractor's employee directly against the Contractor. The Contractor recognizes that this waiver was specifically entered into.

5.2 Contractor Release. Any deviation, alteration, variation, addition, or omission in the Work by Contractor from the Contract Documents shall preclude Contractor from bringing any Claim or request for additional time or compensation on the basis of an alleged defect or error in the Contract Documents related to or arising, in any way, from that deviation, alteration, variation, addition, or omission. The Contractor further warrants that any alteration, variation, deletion, or omission fully complies with or exceeds all requirements of the Contract Documents and assumes all risk thereof.

5.3 Survival. The provisions of this Section shall (1) survive the expiration or termination of this Contract with respect to any event occurring prior to such expiration or termination, final payment hereunder, and any applicable statute of repose with respect to claims, fines, costs or damages brought or made against any Indemnified Party; (2) shall not be limited by RCW 4.16326(g); and (3) are in addition to any other rights or remedies which the City and/or any of the Indemnified Parties may have by law or under this Contract.

5.4 Offset. In the event of any claim or demand made against any Indemnified Party hereunder, the City may, in its sole discretion, reserve, retain or apply any monies due to the Contractor under the Contract or any other agreement or contract with the City for the purpose of resolving such claims; provided, however, that the City may, in the City's sole discretion, release such funds if the Contractor provides the City with adequate assurance of the protection of the City's and the other Indemnified Parties interests.

5.5 The Contractor shall ensure that each Subcontract includes a provision requiring each Subcontractor to indemnify and defend the City and the Indemnified Parties in the same manner, to the same extent, and for the same duration as Contractor agrees to indemnify and defend the City and the Indemnified Parties in this Section 5.

## **6. OWNERSHIP OF DOCUMENTS**

All originals and copies of work product, including plans, sketches, layouts, designs, design specifications, records, files, computer disks, magnetic media, all finished or unfinished documents or material which may be produced or modified by Contractor while performing the Work, whether or not required to be furnished to the City, shall become the property of the City, shall be delivered to the City at its request, and may be used by the City without restriction.

## **7. PATENTS, COPYRIGHTS, AND RIGHTS IN DATA**

7.1 Any patentable result or material suitable for copyright arising out of this Contract shall be owned by and made available to the City for public use, unless the City shall, in a specific case where it is legally permissible, determine that it is in the public interest that it not be so owned or available.

7.2 The Contractor agrees that the ownership of any plans, drawings, designs, specifications, computer programs, technical reports, operating manuals, calculations, notes and other work submitted or which is specified to be delivered under this Contract, whether or not complete (referred to in this subsection as "Subject Data"), is hereby irrevocably transferred and assigned to the City and shall be vested in the City or such other local, state or federal agency, if any, as may be provided by separate contract with the City. The Contractor shall execute and deliver such instruments and take such other action(s) as may be requested by the City to perfect or protect the City's rights to such Subject Data and work product, and to perfect the assignments and transfers contemplated in Sections 6 and 7.

7.3 All such Subject Data furnished by the Contractor pursuant to this Contract, other than documents exclusively for internal use by the City, shall carry such notations on the front cover or a title page (or in such case of maps, in the same block) as may be requested by the City. The Contractor shall also place their endorsement on all Subject Data furnished by them. All such identification details shall be subject to approval by the City prior to printing.

7.4 The Contractor shall ensure that substantially the foregoing paragraphs in Sections 6 and 7 are included in each subcontract for the work on the Project.

## **8. GENERAL PROVISIONS**

8.1 Entire Contract. The Contract Documents contain all of the agreements of the Parties with respect to any matter covered or mentioned in this Contract and no prior agreements or understandings pertaining to any such matters shall be effective for any purpose. In entering into this Contract, neither party has relied upon any statement, estimate, forecast, projection, representation, warranty, action or agreement of the other party except for those expressly contained in the Contract Documents.

8.2 Documents. The documents incorporated by reference, as if fully set forth in this Contract, are the Advertisement for Bids, the Instructions to Bidders and Checklists, the Contractor's Bid Proposal (including all forms and supplemental information listed on the Bidders Checklist), the Contract Documents (including Project Plans, Specifications, and all Appendices, Amendments, and Supplemental Reports & Information), the Contract Provisions (including all forms and supplemental information listed on the Contract Checklist), the version of the Washington State Standard Specifications for Road, Bridge, and Municipal Construction identified herein, and any other documents provided to bidders and/or referenced in or referred to by the Contract Documents.

8.3 Modification. No provisions of this Contract, including this provision, may be amended or added to except by agreement in writing signed by the Parties or their respective successors in interest in accordance with the Contract Documents.

8.4 Change Orders. In addition to its rights under the Contract Documents, the City may unilaterally issue a Change Order at any time making changes within the general scope of the Contract, without invalidating the Contract and without providing notice to sureties. The City's issuance of a unilateral Change Order shall not be construed as a waiver of any rights afforded the City, including its right to reject a prior protest or request for change or Claim due to untimeliness or the Contractor's failure to fully comply with the requirements of the Contract Documents, or to void the unilateral Change Order due to unilateral mistake, misrepresentation, or fraud.

8.5 Total Cost Method / Claims. In no event shall a Total Cost Method or a modified Total Cost Method be used by the Contractor to calculate any adjustments to the Contract price. For the purpose of this provision, any cost method, or variety of cost methods, using the difference between the actual cost of the Work and the Bid or Contract price of the Work to calculate any additional compensation or money owed to the Contractor shall be considered a Total Cost Method. In addition, the City shall not be responsible for, and the Contractor shall not be entitled to, any compensation for unallowable costs. Unallowable costs include, but are not limited to: (i) interest or attorneys' fees, except as mandated by statute; (ii) Claim preparation or filing costs; (iii) the costs of preparing notices or protests; (iv) lost profits, lost income, or lost earnings; (v) costs for idle equipment when such equipment is not at the Site, has not been employed in the Work, or is not scheduled to be used at the Site; (vi) claims consulting costs; (vii) expert fees and costs; (viii) loss of other business; and/or (ix) any other special, consequential, expectancy, incidental, or indirect damages incurred by the Contractor, Subcontractors, or suppliers.

8.6 Warranties and Guarantees. In addition to the requirements of the Contract Documents, the Contractor warrants that all portions of the Work that will be covered by a manufacturer's or supplier's guarantee or warranty shall be performed in such a manner so as to preserve all rights under such guarantees or warranties. If the City attempts to enforce a claim based upon a manufacturer's or supplier's guarantee or warranty and such manufacturer or supplier refuses to honor such guarantee or warranty based, in whole or in part, on a claim of defective installation by the Contractor or a Subcontractor, the Contractor shall be responsible for any resulting loss or damage, and repairs, incurred by the City as a result of the manufacturer's or supplier's refusal to honor such guarantee or warranty. This obligation survives termination of this Contract.

8.7 Full Force and Effect. Any provision of this Contract, which is declared invalid, void or illegal, shall in no way affect, impair, or invalidate any other provision hereof and such other provisions shall remain in full force and effect.

8.8 Assignment. The Contractor shall not transfer or assign, in whole or in part, any or all of its obligations and rights hereunder without the prior written consent of the City. In the event the City consents to any such assignment or transfer, such consent shall in no way release the Contractor from any of its obligations or liabilities under this Contract.

8.9 Successors In Interest. Subject to the preceding Subsection, this Contract shall be binding upon and inure to the benefit of the Parties' successors in interest, heirs and assigns.

8.10 Time Limitation and Venue. For the convenience of the parties to the Contract it is mutually agreed by the parties that any claims, causes of action, or disputes which the Contractor has against the City arising from the Contract shall be brought within the following time period: (i) 180 calendar days from the date of Substantial Completion for those claims, causes of action, or disputes arising prior to the date of Substantial Completion, and (ii) 180 calendar days from the date of Final Acceptance of the Contract by the City for those claims, causes of action, or dispute arising after the date of Substantial Completion. It is further agreed that the venue for any claim, cause of action, or dispute related to this Contract shall be King County, Washington, which shall have exclusive jurisdiction over any such case, controversy, or dispute. The parties understand and agree that the Contractor's failure to bring suit within the time period provided, shall be a complete bar to any such claims or causes of action. It is further mutually agreed by the parties that when any claims, causes of action, or disputes which the Contractor asserts against the City arising from the Contract are filed with the City or initiated in court, the Contractor shall permit the City to have timely access to any records deemed necessary by the City to assist in evaluating the claims, action, or dispute.

8.11 No Waiver. Failure of the City to declare any breach or default immediately upon occurrence thereof, or delay in taking any action in connection with, shall not waive such breach or default. Failure of the City to declare one breach or default does not act as a waiver of the City's right to declare another breach or default.

8.12 Sole Authority/Discretion/Judgment. Where the Contract Documents provide the City or its Engineer with "sole" authority, discretion, or judgment, such authority, discretion, or judgment shall be considered unconditional and absolute.

8.13 Governing Law. This Contract shall be made in and shall be governed by and interpreted in accordance with the laws of the State of Washington.

8.14 Authority. Each individual executing this Contract on behalf of the City and Contractor represents and warrants that such individuals are duly authorized to execute and deliver this Contract on behalf of the Contractor or City.

8.15 Engineer. The Engineer is the City's representative who directly supervises the engineering and administration of a construction Contract. The Engineer's authorities, duties, and responsibilities are limited to those specifically identified in the Contract Documents. Designation of an individual or entity as the Engineer for the Project is solely to identify the representative of the City as the entity to act as the Engineer as described in the Contract Documents. Using the term "engineer" does not imply that such entity or person is a licensed professional engineer or an engineering company and does not import any additional obligations upon the actions of the Engineer that may govern licensed professional engineers when performing engineering services.

The Engineer for this Project is designated as: Omar Barron, PE, City of Federal Way Senior Civil Engineer.

8.16 Notices. Any notices required to be given to Contractor or to the Engineer shall be delivered to the Parties at the addresses set forth below. Any notices may be delivered personally to the addressee of the notice or may be deposited in the United States mail, postage prepaid, to the address set forth herein. Any notice so posted in the United States mail shall be deemed received three (3) days after the date of mailing.

CONTRACTOR: Company  
Attn: Individual to receive notices  
Street Address  
City, State, Zip

ENGINEER: City of Federal Way  
Attn: Omar Barron, PE  
33325 8th Ave S  
Federal Way, WA 98003

8.17 Captions. The respective captions of the Sections of this Contract are inserted for convenience of reference only and shall not be deemed to modify or otherwise affect in any respect any of the provisions of this Contract.

8.18 Performance. Time is of the essence of this Contract and each and all of its provisions in which performance is a factor. Adherence to completion dates is essential to the Contractor's performance of this Contract.

8.19 Compliance with Ethics Code. If a violation of the City's Ethics Resolution No. 91-54, as amended, occurs as a result of the formation and/or performance of this Contract, this Contract may be rendered null and void, at the City's option.

**9. PERFORMANCE/PAYMENT BOND**

Pursuant to RCW 39.08.010, the Contractor's payment and performance bonds must be conditioned upon: (i) faithful performance of all of the provisions of the Contract, including warranty obligations; (ii) the payment of all laborers, mechanics, Subcontractors, and Suppliers, and all persons who supply such persons with provisions or supplies in carrying out the Work; and (iii) payment of any taxes, liabilities, increases, or penalties incurred on the Project under Titles 50, 51, and 82 RCW which may be due on (a) projects referred to in RCW 60.28.011(1)(b), and (b) projects for which the bond is conditioned on the payment of such taxes, liabilities, increases, or penalties. Contractor's obligations under this Contract shall not be limited to the dollar amount of the bond.

DATED the day and year set forth above.

**CITY OF FEDERAL WAY:**

**CONTRACTOR:**

\_\_\_\_\_  
*Jim Ferrell, Mayor*  
33325 8th Avenue South  
Federal Way, WA 98003-6325

\_\_\_\_\_  
*Signature of Authorized Individual*

**ATTEST:**

\_\_\_\_\_  
*Printed Name of Authorized Individual*

\_\_\_\_\_  
*Stephanie Courtney, CMC, City Clerk*

\_\_\_\_\_  
*Street Address*

**APPROVED AS TO FORM:**

\_\_\_\_\_  
*City, State, Zip*

\_\_\_\_\_  
*J. Ryan Call, City Attorney*

**NOTARY OF CONTRACTOR'S SIGNATURE:**

STATE OF WASHINGTON     )  
  ) ss.  
COUNTY OF \_\_\_\_\_)

On this day personally appeared before me \_\_\_\_\_, to me known to be the \_\_\_\_\_ of \_\_\_\_\_ that executed the foregoing instrument, and acknowledged the said instrument to be the free and voluntary act and deed of said corporation, for the uses and purposes therein mentioned, and on oath stated that he/she was authorized to execute said instrument and that the seal affixed, if any, is the corporate seal of said corporation.

GIVEN my hand and official seal this \_\_\_\_\_ day of \_\_\_\_\_, 20\_\_.

\_\_\_\_\_  
\_\_\_\_\_  
*(typed/printed name of notary)*  
*Notary Public in and for the State of Washington.*  
*My commission expires \_\_\_\_\_*





**CERTIFICATE OF INSURANCE**

*Contractor's Certificate of  
Insurance to be inserted  
here during Contract  
Execution*





**LOCAL OFFICE/AGENT OF SURETY:**

\_\_\_\_\_  
*Name*

\_\_\_\_\_  
*Street Address*

\_\_\_\_\_  
*City, State, Zip*

\_\_\_\_\_  
*Telephone*

**BOND NO.:** \_\_\_\_\_

**APPROVED AS TO FORM:** \_\_\_\_\_  
*J. Ryan Call, City Attorney*

# CONTRACTOR'S RETAINAGE OPTION

## IDENTIFICATION AND DESCRIPTION

Project Title: Former Target Building Demolition

RFB No: 23-002

Contractor: \_\_\_\_\_

## GENERAL REQUIREMENTS

1. In accordance with applicable State Statutes, a contract retainage not to exceed five percent of the moneys earned by the contractor will be reserved by the City.
2. All investments selected are subject to City approval.
3. The final disposition of the contract retainage will be made in accordance with applicable State Statutes.

## CONTRACTOR'S INSTRUCTIONS

Pursuant to RCW 60.28.011, I hereby notify the City of Federal Way of my instructions for the retainage withheld under the terms of this contract:

- Option 1:** Retained in a fund by the City of Federal Way. No interest will be paid to the contractor.
- Option 2:** Deposited in an interest bearing account in a bank, mutual savings bank, or savings and loan association. Interest paid to the contractor. Contractor shall have the bank (or other) execute a separate "City of Federal Way Retainage Bank Acceptance Agreement" upon contract award. The City will provide the agreement to the Contractor if this option is selected.
- Option 3:** Placed in escrow with a bank or trust company. Contractor shall execute, and have escrow account holder execute a separate "City of Federal Way Construction Retainage Escrow Agreement" upon contract award. The City will provide the agreement to the Contractor if this option is selected. All investments are subject to City approval. The cost of the investment program, and risk thereof, is to be borne entirely by the contractor.
- Option 4:** Contractor shall submit a "Retainage Bond" on City-provided form included in these Contract Documents.

\_\_\_\_\_  
*Contractor Signature* *Date*

**RETAINAGE BOND TO CITY OF FEDERAL WAY**  
**FORMER TARGET BUILDING DEMOLITION**

KNOW ALL PERSONS BY THESE PRESENTS that we, the undersigned, \_\_\_\_\_, as principal ("Principal"), and \_\_\_\_\_, a Corporation organized and existing under the laws of the State of \_\_\_\_\_, as a surety Corporation, and qualified under the laws of the State of Washington to become surety upon bonds of Contractors with Municipal Corporations, as surety ("Surety"), are jointly and severally held and firmly bonded to the City of Federal Way ("City") in the penal sum of: \_\_\_\_\_ (\$ \_\_\_\_\_) for the payment of which sum we bind ourselves and our successors, heirs, administrators or personal representatives, as the case may be.

A. This obligation is entered into in pursuant to the statutes of the State of Washington and the ordinances, regulations, standards and policies of the City, as now existing or hereafter amended or adopted.

B. Pursuant to proper authorization, the Mayor is authorized to enter into a certain contract with the Principal, providing for the above-referenced Project, which contract is incorporated herein by this reference ("Contract"), and

C. Pursuant to State law, Chapter 60.28 RCW, the City is required to reserve from the monies earned by the Principal pursuant to the contract, a sum not to exceed five percent (5%), said sum to be retained by the City as a trust fund for the protection and payment of any person or persons, mechanic, subcontractor or material men who shall perform any labor upon such contract or the doing of such work, and all persons who shall supply such person or persons or subcontractors with provisions and supplies for the carrying on of such work, and the State with the respect to taxes imposed pursuant to Title 82 RCW which may be due from said Principal. Every person performing labor or furnishing supplies towards completion of said improvement or work shall have a lien on said monies so reserved, provided that such notice of the lien of such claimant shall be given in the manner and within the time provided in RCW 39.08.030 as now existing and in accordance with any amendments that may hereafter be provided thereto; and

D. State law further provides that with the consent of the City, the Principal may submit a bond for all or any portion of the amount of funds retained by the public body in a form acceptable to the public body conditioned upon such bond any proceeds therefrom being made subject to all claims and liens and in the same manner and priority as set forth retained percentages pursuant to Chapter 60.28 RCW; and

E. The Principal has accepted, or is about to accept, the Contract, and undertake to perform the work therein provided for in the manner and within the time set forth, for the amount of \$ \_\_\_\_\_; and

F. The City is prepared to release any required retainage money previously paid by the Principal prior to acceptance and successful operation and fulfillment of all other terms of said contract upon being indemnified by these presents,

NOW, THEREFORE, if the Principal shall perform all the provisions of the Contract in the manner and within the time period prescribed by the City, or within such extensions of time as may be granted under the Contract, and shall pay all laborers, mechanics, subcontractors and material men or women, and all persons who shall supply the Principal or subcontractors with provisions and supplies for the carrying on of said work, and if the Principal shall pay to the State all taxes imposed pursuant to Title 82 RCW which may be due from such Principal as a result of this contract then and in the event this obligation shall be void; but otherwise it shall be and remain in full force and effect.

And the Surety, for value received, hereby further stipulates and agrees that no change, extension of time, alteration or addition to the terms of the Contract or to the work to be performed thereunder or the specifications accompanying the same shall in any way affect its obligation on this bond, and it does hereby waive notice of any change, extension of time, alterations or additions to the terms of the Contract or to the Work.

The Surety hereby agrees that modifications and changes may be made in the terms and provisions of the Contract without notice to Surety, and any such modifications or changes increasing the total amount to be paid the Principal shall automatically increase the obligation of the Surety on this Retainage Bond in a like amount, such increase, however, not to exceed twenty-five percent (25%) of the original amount of this bond without consent of the Surety.

Within forty-five (45) days of receiving notice that the Principal has defaulted on all or part of the terms of the Contract, the Surety shall make written commitment to the City that it will either: (a) cure the default itself within a reasonable time period, or (b) tender to the City, the amount necessary for the City to remedy the default, including legal fees incurred by the City, or (c) in the event that Surety's evaluation of the dispute is not complete or in the event the Surety disputes the City's claim of default, the Surety shall notify the City of its finding and its intent, if any, to interplead. The Surety shall then fulfill its obligations under this bond, according to the option it has elected. Should Surety elect option (a) to cure the default, the penal sum of the Bond shall be reduced in an amount equal to the costs actually incurred by the Surety in curing the default. If the Surety elects option (b), then upon completion of the necessary work, the City shall notify the Surety of its actual costs. The City shall return, without interest, any overpayment made by the Surety and the Surety shall pay to the City any actual costs which exceed the City estimate, limited to the bond amount. Should the Surety elect option (c), the Parties shall first complete participation in mediation, described in the below paragraph, prior to any interplead action.

In the event a dispute should arise between the Parties to this Bond with respect to the City's declaration of default by the Principal, the Parties agree to participate in at least four hours of mediation to resolve said dispute. The Parties shall proportionately share in the cost of the mediation. The mediation shall be administered by Judicial Dispute Resolution, LLC, 1425 Fourth Avenue, Suite 300, Seattle, Washington 98101. The Surety shall not interplead prior to completion of the mediation.

The parties have executed this instrument under their separate seals this \_\_\_\_ day of \_\_\_\_\_, 20\_\_\_\_, the name and corporate seal of each corporate party hereto affixed, and these presents duly signed by its undersigned representatives pursuant to authority of its governing body.

**CORPORATE SEAL:**

**PRINCIPAL:**

By: \_\_\_\_\_

Title: \_\_\_\_\_

Address: \_\_\_\_\_

\_\_\_\_\_

**CORPORATE SEAL:**

**SURETY:**

By: \_\_\_\_\_

*Attorney-in-Fact  
(Attach Power of Attorney)*

Title: \_\_\_\_\_

Address: \_\_\_\_\_

\_\_\_\_\_

**CERTIFICATES AS TO CORPORATE SEAL**

I hereby certify that I am the (Assistant) Secretary of the Corporation named as Principal in the within bond; that \_\_\_\_\_, who signed the said bond on behalf of the Principal, was \_\_\_\_\_ of said Corporation; that I know his or her signature thereto is genuine, and that said bond was duly signed, sealed, and attested for and in behalf of said Corporation by authority of its governing body.

\_\_\_\_\_  
*Secretary of Principal*

I hereby certify that I am the (Assistant) Secretary of the Corporation named as Surety in the within bond; that \_\_\_\_\_, who signed the said bond on behalf of the Surety, was \_\_\_\_\_ of the said Corporation; that I know his or her signature thereto is genuine, and that said bond was duly signed, sealed, and attested for and in behalf of said Corporation by authority of its governing body.

\_\_\_\_\_  
*Secretary of Surety*

**APPROVED AS TO FORM:**

\_\_\_\_\_  
*J. Ryan Call, City Attorney*

---

---

***SPECIAL PROVISIONS***

---

---

# INTRODUCTION TO THE SPECIAL PROVISIONS

## ***(December 10, 2020 APWA GSP)***

The work on this project shall be accomplished in accordance with the *Standard Specifications for Road, Bridge and Municipal Construction*, 2023 edition, as issued by the Washington State Department of Transportation (WSDOT) and the American Public Works Association (APWA), Washington State Chapter (hereafter “Standard Specifications”). The Standard Specifications, as modified or supplemented by these Special Provisions, all of which are made a part of the Contract Documents, shall govern all of the Work.

These Special Provisions are made up of both General Special Provisions (GSPs) from various sources, which may have project-specific fill-ins; and project-specific Special Provisions. Each Provision either supplements, modifies, or replaces the comparable Standard Specification, or is a new Provision. The deletion, amendment, alteration, or addition to any subsection or portion of the Standard Specifications is meant to pertain only to that particular portion of the section, and in no way should it be interpreted that the balance of the section does not apply.

The project-specific Special Provisions are not labeled as such. The GSPs are labeled under the headers of each GSP, with the effective date of the GSP and its source. For example:

*(March 8, 2013 APWA GSP)*

*(April 1, 2013 WSDOT GSP)*

*(April 12, 2018 CFW GSP)*

*(\*\*\*PROJECT-SPECIFIC SPECIAL PROVISION\*\*\*)*

Also incorporated into the Contract Documents by reference are:

- *Manual on Uniform Traffic Control Devices for Streets and Highways*, currently adopted edition, with Washington State modifications, if any
- *Standard Plans for Road, Bridge and Municipal Construction*, WSDOT/APWA, current edition
- City of Federal Way Public Works Development Standards
- National Electric Code, current edition

Contractor shall obtain copies of these publications, at Contractor’s own expense.



# DIVISION 1 GENERAL REQUIREMENTS

## **DESCRIPTION OF WORK**

***(March 13, 1995 WSDOT GSP)***

This Contract provides for the improvement of the Former Target Building Demolition and other work, all in accordance with the attached Contract Plans, these Contract Provisions, and the Standard Specifications.

## **1-01.3 Definitions**

***(January 19, 2022 APWA GSP)***

Delete the heading **Completion Dates** and the three paragraphs that follow it, and replace them with the following:

### **Dates**

#### ***Bid Opening Date***

The date on which the Contracting Agency publicly opens and reads the Bids.

#### ***Award Date***

The date of the formal decision of the Contracting Agency to accept the lowest responsible and responsive Bidder for the Work.

#### ***Contract Execution Date***

The date the Contracting Agency officially binds the Agency to the Contract.

#### ***Notice to Proceed Date***

The date stated in the Notice to Proceed on which the Contract time begins.

#### ***Substantial Completion Date***

The day the Engineer determines the Contracting Agency has full and unrestricted use and benefit of the facilities, both from the operational and safety standpoint, any remaining traffic disruptions will be rare and brief, and only minor incidental work, replacement of temporary substitute facilities, plant establishment periods, or correction or repair remains for the Physical Completion of the total Contract.

#### ***Physical Completion Date***

The day all of the Work is physically completed on the project. All documentation required by the Contract and required by law does not necessarily need to be furnished by the Contractor by this date.

#### ***Completion Date***

The day all the Work specified in the Contract is completed and all the obligations of the Contractor under the contract are fulfilled by the Contractor. All documentation required by the Contract and required by law must be furnished by the Contractor before establishment of this date.

#### ***Final Acceptance Date***

The date on which the Contracting Agency accepts the Work as complete.

Supplement this Section with the following:

All references in the Standard Specifications, Amendments, or WSDOT General Special Provisions, to the terms "Department of Transportation", "Washington State Transportation Commission", "Commission", "Secretary of Transportation", "Secretary", "Headquarters", and "State Treasurer" shall be revised to read "Contracting Agency."

All references to the terms “State” or “state” shall be revised to read “Contracting Agency” unless the reference is to an administrative agency of the State of Washington, a State statute or regulation, or the context reasonably indicates otherwise.

All references to “State Materials Laboratory” shall be revised to read “Contracting Agency designated location.”

All references to “final contract voucher certification” shall be interpreted to mean the Contracting Agency form(s) by which final payment is authorized, and final completion and acceptance granted.

**Additive**

A supplemental unit of work or group of bid items, identified separately in the Bid Proposal, which may, at the discretion of the Contracting Agency, be awarded in addition to the base bid.

**Alternate**

One of two or more units of work or groups of bid items, identified separately in the Bid Proposal, from which the Contracting Agency may make a choice between different methods or material of construction for performing the same work.

**Business Day**

A business day is any day from Monday through Friday except holidays as listed in Section 1-08.5.

**Contract Bond**

The definition in the Standard Specifications for “Contract Bond” applies to whatever bond form(s) are required by the Contract Documents, which may be a combination of a Payment Bond and a Performance Bond.

**Contract Documents**

See definition for “Contract.”

**Contract Time**

The period of time established by the terms and conditions of the Contract within which the Work must be physically completed.

**Notice of Award**

The written notice from the Contracting Agency to the successful Bidder signifying the Contracting Agency’s acceptance of the Bid Proposal.

**Notice to Proceed**

The written notice from the Contracting Agency or Engineer to the Contractor authorizing and directing the Contractor to proceed with the Work and establishing the date on which the Contract time begins.

**Traffic**

Both vehicular and non-vehicular traffic, such as pedestrians, bicyclists, wheelchairs, and equestrian traffic.

**1-02 BID PROCEDURES AND CONDITIONS**

**1-02.1 Prequalification of Bidders**

Delete this Section and replace it with the following:

**1-02.1 Qualifications of Bidder**

***(January 24, 2011 APWA GSP)***

Before award of a public works Contract, a bidder must meet at least the minimum qualifications of RCW 39.04.350(1) to be considered a responsible bidder and qualified to be awarded a public works project.

**1-02.2 Plans and Specifications**

***(June 27, 2011 APWA GSP)***

Delete this section and replace it with the following:

Information as to where Bid Documents can be obtained or reviewed can be found in the Call for Bids (Advertisement for Bids) for the work.

After award of the Contract, Plans and specifications will be issued to the Contractor at no cost as detailed below:

To Prime Contractor	No. of Sets	Basis of Distribution
Reduced Plans (11" x 17")	1	Furnished automatically upon award.
Contract Provisions	1	Furnished automatically upon award.
Large Plans (e.g., 22" x 34")	1	Furnished only upon request.

Additional Plans and Contract Provisions may be obtained by the Contractor from the source stated in the Call for Bids, at the Contractor’s own expense.

**1-02.4 Examination of Plans, Specifications, and Site Work**

***(June 27, 2011 APWA GSP)***

**1-02.4(1) General**

***(January 19, 2022 APWA GSP, Option B)***

The first sentence of the ninth paragraph, beginning with “Any prospective Bidder desiring...”, is revised to read:

Any prospective Bidder desiring an explanation or interpretation of the Bid Documents, shall request the explanation or interpretation in writing by close of business three (3) business days preceding the bid opening to allow a written reply to reach all prospective Bidders before the submission of their Bids.

**1-02.5 Proposal Forms**

***(July 31, 2017 APWA GSP)***

Delete this section and replace it with the following:

The Proposal Form will identify the project and its location and describe the work. It will also list estimated quantities, units of measurement, the items of work, and the materials to be furnished at the unit bid prices. The bidder shall complete spaces on the proposal form that call for, but are not limited to, unit prices; extensions; summations; the total bid amount; signatures; date; and, where applicable, retail sales taxes and acknowledgment of addenda; the bidder’s name, address, telephone number, and signature; the bidder’s UBDE/DBE/M/WBE commitment, if applicable; a State of Washington Contractor’s Registration Number; and a Business License Number, if applicable. Bids shall be

completed by typing or shall be printed in ink by hand, preferably in black ink. The required certifications are included as part of the Proposal Form.

The Contracting Agency reserves the right to arrange the proposal forms with alternates and additives, if such be to the advantage of the Contracting Agency. The bidder shall bid on all alternates and additives set forth in the Proposal Form unless otherwise specified.

Add the following new section:

**1-02.6(1) Recycled Materials Proposal**  
***(January 4, 2016 APWA GSP)***

The Bidder shall submit with the Bid, its proposal for incorporating recycled materials into the project, using the form provided in the Contract Provisions.

**1-02.7 Bid Deposit**  
***(March 8, 2013 APWA GSP)***

Supplement this section with the following:

Bid bonds shall contain the following:

1. Contracting Agency-assigned number for the project;
2. Name of the project;
3. The Contracting Agency named as obligee;
4. The amount of the bid bond stated either as a dollar figure or as a percentage which represents five percent of the maximum bid amount that could be awarded;
5. Signature of the bidder's officer empowered to sign official statements. The signature of the person authorized to submit the bid should agree with the signature on the bond, and the title of the person must accompany the said signature;
6. The signature of the surety's officer empowered to sign the bond and the power of attorney.

If so stated in the Contract Provisions, bidder must use the bond form included in the Contract Provisions.

If so stated in the Contract Provisions, cash will not be accepted for a bid deposit.

**1-02.10 Withdrawing, Revising, or Supplementing Proposal**  
***(July 23, 2015 APWA GSP)***

Delete this section, and replace it with the following:

After submitting a physical Bid Proposal to the Contracting Agency, the Bidder may withdraw, revise, or supplement it if:

1. The Bidder submits a written request signed by an authorized person and physically delivers it to the place designated for receipt of Bid Proposals, and
2. The Contracting Agency receives the request before the time set for receipt of Bid Proposals, and
3. The revised or supplemented Bid Proposal (if any) is received by the Contracting Agency before the time set for receipt of Bid Proposals.

If the Bidder's request to withdraw, revise, or supplement its Bid Proposal is received before the time set for receipt of Bid Proposals, the Contracting Agency will return the unopened Proposal package to the Bidder. The Bidder must then submit the revised or supplemented package in its entirety. If the Bidder does not submit a revised or supplemented package, then its bid shall be considered withdrawn.

Late revised or supplemented Bid Proposals or late withdrawal requests will be date recorded by the Contracting Agency and returned unopened. Mailed, emailed, or faxed requests to withdraw, revise, or supplement a Bid Proposal are not acceptable.

**1-02.13 Irregular Proposals**  
**(October 1, 2020 APWA GSP)**

Delete this section and replace it with the following:

1. A Proposal will be considered irregular and will be rejected if:
  - a. The Bidder is not prequalified when so required;
  - b. The authorized Proposal form furnished by the Contracting Agency is not used or is altered;
  - c. The completed Proposal form contains any unauthorized additions, deletions, alternate Bids, or conditions;
  - d. The Bidder adds provisions reserving the right to reject or accept the award, or enter into the Contract;
  - e. A price per unit cannot be determined from the Bid Proposal;
  - f. The Proposal form is not properly executed;
  - g. The Bidder fails to submit or properly complete a Subcontractor list, if applicable, as required in Section 1-02.6;
  - h. The Bidder fails to submit or properly complete an Disadvantaged Business Enterprise Certification, if applicable, as required in Section 1-02.6;
  - i. The Bidder fails to submit written confirmation from each DBE firm listed on the Bidder's completed DBE Utilization Certification that they are in agreement with the bidder's DBE participation commitment, if applicable, as required in Section 1-02.6, or if the written confirmation that is submitted fails to meet the requirements of the Special Provisions;
  - j. The Bidder fails to submit DBE Good Faith Effort documentation, if applicable, as required in Section 1-02.6, or if the documentation that is submitted fails to demonstrate that a Good Faith Effort to meet the Condition of Award was made;
  - k. The Bidder fails to submit a DBE Bid Item Breakdown form, if applicable, as required in Section 1-02.6, or if the documentation that is submitted fails to meet the requirements of the Special Provisions;
  - l. The Bidder fails to submit DBE Trucking Credit Forms, if applicable, as required in Section 1-02.6, or if the documentation that is submitted fails to meet the requirements of the Special Provisions;
  - m. The Bid Proposal does not constitute a definite and unqualified offer to meet the material terms of the Bid invitation; or
  - n. More than one Proposal is submitted for the same project from a Bidder under the same or different names.
  
2. A Proposal may be considered irregular and may be rejected if:
  - a. The Proposal does not include a unit price for every Bid item;

- b. Any of the unit prices are excessively unbalanced (either above or below the amount of a reasonable Bid) to the potential detriment of the Contracting Agency;
- c. Receipt of Addenda is not acknowledged;
- d. A member of a joint venture or partnership and the joint venture or partnership submit Proposals for the same project (in such an instance, both Bids may be rejected); or
- e. If Proposal form entries are not made in ink.

**1-02.14 Disqualification of Bidders**  
***(May 17, 2018 APWA GSP, OPTION B)***

Delete this section and replace it with the following:

A Bidder will be deemed not responsible if the Bidder does not meet the mandatory bidder responsibility criteria in RCW 39.04.350(1), as amended; or does not meet Supplemental Criteria 1-7 listed in this Section.

Contracting Agency will verify that the Bidder meets the mandatory bidder responsibility criteria in RCW 39.04.350(1), and Supplemental Criteria 1-2. Evidence that the Bidder meets Supplemental Criteria 3-7 shall be provided by the Bidder as stated later in this Section.

**1. Delinquent State Taxes**

- A. Criterion: The Bidder shall not owe delinquent taxes to the Washington State Department of Revenue without a payment plan approved by the Department of Revenue.
- B. Documentation: The Bidder, if and when required as detailed below, shall sign a statement (on a form to be provided by the Contracting Agency) that the Bidder does not owe delinquent taxes to the Washington State Department of Revenue, or if delinquent taxes are owed to the Washington State Department of Revenue, the Bidder must submit a written payment plan approved by the Department of Revenue, to the Contracting Agency by the deadline listed below.

**2. Federal Debarment**

- A. Criterion: The Bidder shall not currently be debarred or suspended by the Federal government.
- B. Documentation: The Bidder shall not be listed as having an “active exclusion” on the U.S. government’s “System for Award Management” database ([www.sam.gov](http://www.sam.gov)).

**3. Subcontractor Responsibility**

- A. Criterion: The Bidder’s standard subcontract form shall include the subcontractor responsibility language required by RCW 39.06.020, and the Bidder shall have an established procedure which it utilizes to validate the responsibility of each of its subcontractors. The Bidder’s subcontract form shall also include a requirement that each of its subcontractors shall have and document a similar procedure to determine whether the sub-tier subcontractors with whom it contracts are also “responsible” subcontractors as defined by RCW 39.06.020.

- B. Documentation: The Bidder, if and when required as detailed below, shall submit a copy of its standard subcontract form for review by the Contracting Agency, and a written description of its procedure for validating the responsibility of subcontractors with which it contracts.

4. **Claims Against Retainage and Bonds**

- A. Criterion: The Bidder shall not have a record of excessive claims filed against the retainage or payment bonds for public works projects in the three years prior to the bid submittal date, that demonstrate a lack of effective management by the Bidder of making timely and appropriate payments to its subcontractors, suppliers, and workers, unless there are extenuating circumstances and such circumstances are deemed acceptable to the Contracting Agency.

- B. Documentation: The Bidder, if and when required as detailed below, shall submit a list of the public works projects completed in the three years prior to the bid submittal date that have had claims against retainage and bonds and include for each project the following information:

- Name of project
- The owner and contact information for the owner;
- A list of claims filed against the retainage and/or payment bond for any of the projects listed;
- A written explanation of the circumstances surrounding each claim and the ultimate resolution of the claim.

5. **Public Bidding Crime**

- A. Criterion: The Bidder and/or its owners shall not have been convicted of a crime involving bidding on a public works contract in the five years prior to the bid submittal date.

- B. Documentation: The Bidder, if and when required as detailed below, shall sign a statement (on a form to be provided by the Contracting Agency) that the Bidder and/or its owners have not been convicted of a crime involving bidding on a public works contract.

6. **Termination for Cause / Termination for Default**

- A. Criterion: The Bidder shall not have had any public works contract terminated for cause or terminated for default by a government agency in the five years prior to the bid submittal date, unless there are extenuating circumstances and such circumstances are deemed acceptable to the Contracting Agency.

- B. Documentation: The Bidder, if and when required as detailed below, shall sign a statement (on a form to be provided by the Contracting Agency) that the Bidder has not had any public works contract terminated for cause or terminated for default by a government agency in the five years prior to the bid submittal date; or if Bidder was terminated, describe the circumstances. .

7. **Lawsuits**

- A. Criterion: The Bidder shall not have lawsuits with judgments entered against the Bidder in the five years prior to the bid submittal date that demonstrate a pattern of failing to meet the terms of contracts, unless there are extenuating

circumstances and such circumstances are deemed acceptable to the Contracting Agency

- B. Documentation: The Bidder, if and when required as detailed below, shall sign a statement (on a form to be provided by the Contracting Agency) that the Bidder has not had any lawsuits with judgments entered against the Bidder in the five years prior to the bid submittal date that demonstrate a pattern of failing to meet the terms of contracts, or shall submit a list of all lawsuits with judgments entered against the Bidder in the five years prior to the bid submittal date, along with a written explanation of the circumstances surrounding each such lawsuit. The Contracting Agency shall evaluate these explanations to determine whether the lawsuits demonstrate a pattern of failing to meet of terms of construction related contracts

As evidence that the Bidder meets the Supplemental Criteria stated above, the apparent low Bidder must submit to the Contracting Agency by 12:00 P.M. (noon) of the second business day following the bid submittal deadline, a written statement verifying that the Bidder meets the supplemental criteria together with supporting documentation (sufficient in the sole judgment of the Contracting Agency) demonstrating compliance with the Supplemental Criteria. The Contracting Agency reserves the right to request further documentation as needed from the low Bidder and documentation from other Bidders as well to assess Bidder responsibility and compliance with all bidder responsibility criteria. The Contracting Agency also reserves the right to obtain information from third-parties and independent sources of information concerning a Bidder's compliance with the mandatory and supplemental criteria, and to use that information in their evaluation. The Contracting Agency may consider mitigating factors in determining whether the Bidder complies with the requirements of the supplemental criteria.

The basis for evaluation of Bidder compliance with these mandatory and supplemental criteria shall include any documents or facts obtained by Contracting Agency (whether from the Bidder or third parties) including but not limited to: (i) financial, historical, or operational data from the Bidder; (ii) information obtained directly by the Contracting Agency from others for whom the Bidder has worked, or other public agencies or private enterprises; and (iii) any additional information obtained by the Contracting Agency which is believed to be relevant to the matter.

If the Contracting Agency determines the Bidder does not meet the bidder responsibility criteria above and is therefore not a responsible Bidder, the Contracting Agency shall notify the Bidder in writing, with the reasons for its determination. If the Bidder disagrees with this determination, it may appeal the determination within two (2) business days of the Contracting Agency's determination by presenting its appeal and any additional information to the Contracting Agency. The Contracting Agency will consider the appeal and any additional information before issuing its final determination. If the final determination affirms that the Bidder is not responsible, the Contracting Agency will not execute a contract with any other Bidder until at least two business days after the Bidder determined to be not responsible has received the Contracting Agency's final determination.

Request to Change Supplemental Bidder Responsibility Criteria Prior To Bid: Bidders with concerns about the relevancy or restrictiveness of the Supplemental Bidder Responsibility Criteria may make or submit requests to the Contracting Agency to modify the criteria.



Such requests shall be in writing, describe the nature of the concerns, and propose specific modifications to the criteria. Bidders shall submit such requests to the Contracting Agency no later than five (5) business days prior to the bid submittal deadline and address the request to the Project Engineer or such other person designated by the Contracting Agency in the Bid Documents.

## **1-03 AWARD AND EXECUTION OF CONTRACT**

### **1-03.1 Consideration of Bids** ***(January 23, 2006 APWA GSP)***

Revise the first paragraph to read:

After opening and reading proposals, the Contracting Agency will check them for correctness of extensions of the prices per unit and the total price. If a discrepancy exists between the price per unit and the extended amount of any bid item, the price per unit will control. If a minimum bid amount has been established for any item and the bidder's unit or lump sum price is less than the minimum specified amount, the Contracting Agency will unilaterally revise the unit or lump sum price, to the minimum specified amount and recalculate the extension. The total of extensions, corrected where necessary, including sales taxes where applicable and such additives and/or alternates as selected by the Contracting Agency, will be used by the Contracting Agency for award purposes and to fix the Awarded Contract Price amount and the amount of the contract bond.

### **1-03.1(1) Identical Bid Totals** ***(January 4, 2016 APWA GSP)***

Revise this section to read:

After opening Bids, if two or more lowest responsive Bid totals are exactly equal, then the tie-breaker will be the Bidder with an equal lowest bid, that proposed to use the highest percentage of recycled materials in the Project, per the form submitted with the Bid Proposal. If those percentages are also exactly equal, then the tie-breaker will be determined by drawing as follows: Two or more slips of paper will be marked as follows: one marked "Winner" and the other(s) marked "unsuccessful." The slips will be folded to make the marking unseen. The slips will be placed inside a box. One authorized representative of each Bidder shall draw a slip from the box. Bidders shall draw in alphabetic order by the name of the firm as registered with the Washington State Department of Licensing. The slips shall be unfolded and the firm with the slip marked "Winner" will be determined to be the successful Bidder and eligible for Award of the Contract. Only those Bidders who submitted a Bid total that is exactly equal to the lowest responsive Bid, and with a proposed recycled materials percentage that is exactly equal to the highest proposed recycled materials amount, are eligible to draw.

### **1-03.3 Execution of Contract** ***(January 19, 2022 APWA GSP)***

Revise this section to read:

Within 3 calendar days of Award date (not including Saturdays, Sundays, and Holidays), the successful Bidder shall provide the information necessary to execute the Contract to the Contracting Agency. The Bidder shall send the contact information, including the full name, email address, and phone number, for the authorized signer and bonding agent to the Contracting Agency.

Copies of the Contract Provisions, including the unsigned Form of Contract, will be available for signature by the successful bidder on the first business day following award. The number of copies to be executed by the Contractor will be determined by the Contracting Agency.

Within 10 calendar days after the award date, the successful bidder shall return the signed Contracting Agency-prepared contract, an insurance certification as required by Section 1-07.18, and a satisfactory bond as required by law and Section 1-03.4, the Transfer of Coverage form for the Construction Stormwater General Permit with sections I, III, and VIII completed when provided. Before execution of the contract by the Contracting Agency, the successful bidder shall provide any pre-award information the Contracting Agency may require under Section 1-02.15.

Until the Contracting Agency executes a contract, no proposal shall bind the Contracting Agency nor shall any work begin within the project limits or within Contracting Agency-furnished sites. The Contractor shall bear all risks for any work begun outside such areas and for any materials ordered before the contract is executed by the Contracting Agency.

If the bidder experiences circumstances beyond their control that prevents return of the contract documents within the calendar days after the award date stated above, the Contracting Agency may grant up to a maximum of 5 additional calendar days for return of the documents, provided the Contracting Agency deems the circumstances warrant it.

**1-03.4 Contract Bond**  
***(July 23, 2015 APWA GSP)***

Delete the first paragraph and replace it with the following:

The successful bidder shall provide executed payment and performance bond(s) for the full contract amount. The bond may be a combined payment and performance bond; or be separate payment and performance bonds. In the case of separate payment and performance bonds, each shall be for the full contract amount. The bond(s) shall:

1. Be on Contracting Agency-furnished form(s);
2. Be signed by an approved surety (or sureties) that:
  - a. Is registered with the Washington State Insurance Commissioner, and
  - b. Appears on the current Authorized Insurance List in the State of Washington published by the Office of the Insurance Commissioner,
3. Guarantee that the Contractor will perform and comply with all obligations, duties, and conditions under the Contract, including but not limited to the duty and obligation to indemnify, defend, and protect the Contracting Agency against all losses and claims related directly or indirectly from any failure:
  - a. Of the Contractor (or any of the employees, subcontractors, or lower tier subcontractors of the Contractor) to faithfully perform and comply with all contract obligations, conditions, and duties, or
  - b. Of the Contractor (or the subcontractors or lower tier subcontractors of the Contractor) to pay all laborers, mechanics, subcontractors,

lower tier subcontractors, material person, or any other person who provides supplies or provisions for carrying out the work;

4. Be conditioned upon the payment of taxes, increases, and penalties incurred on the project under titles 50, 51, and 82 RCW; and
5. Be accompanied by a power of attorney for the Surety's officer empowered to sign the bond; and
6. Be signed by an officer of the Contractor empowered to sign official statements (sole proprietor or partner). If the Contractor is a corporation, the bond(s) must be signed by the president or vice president, unless accompanied by written proof of the authority of the individual signing the bond(s) to bind the corporation (i.e., corporate resolution, power of attorney, or a letter to such effect signed by the president or vice president).

### **1-03.7 Judicial Review**

#### ***(November 30, 2018 APWA GSP)***

Revise this section to read:

Any decision made by the Contracting Agency regarding the Award and execution of the Contract or Bid rejection shall be conclusive subject to the scope of judicial review permitted under Washington Law. Such review, if any, shall be timely filed in the Superior Court of the county where the Contracting Agency headquarters is located, provided that where an action is asserted against a county, RCW 36.01.050 shall control venue and jurisdiction.

### **1-04 SCOPE OF THE WORK**

#### **1-04.2 Coordination of Contract Documents, Plans, Special Provisions, Specifications, and Addenda**

##### ***(January 8, 2021 CFW GSP)***

Revise the second paragraph to read:

Any inconsistency in the parts of the contract shall be resolved by following this order of precedence (e.g., 1 presiding over 2, 2 over 3, 3 over 4, and so forth):

1. Contract,
2. Change Orders, with those of a later date taking precedence of those of an earlier date,
3. Addenda, with those of a later date taking precedence of those of an earlier date,
4. Proposal Form,
5. Special Provisions,
6. Contract Plans,
7. Standard Specifications,
8. Contracting Agency's Standard Plans or Details (if any), and
9. WSDOT Standard Plans for Road, Bridge, and Municipal Construction.

#### **1-04.4 Changes**

##### ***(January 19, 2022 APWA GSP)***

The first two sentences of the last paragraph of Section 1-04.4 are deleted.

## **1-05 CONTROL OF WORK**

### **1-05.7 Removal of Defective and Unauthorized Work**

***(October 1, 2005 APWA GSP)***

Supplement this section with the following:

If the Contractor fails to remedy defective or unauthorized work within the time specified in a written notice from the Engineer, or fails to perform any part of the work required by the Contract Documents, the Engineer may correct and remedy such work as may be identified in the written notice, with Contracting Agency forces or by such other means as the Contracting Agency may deem necessary.

If the Contractor fails to comply with a written order to remedy what the Engineer determines to be an emergency situation, the Engineer may have the defective and unauthorized work corrected immediately, have the rejected work removed and replaced, or have work the Contractor refuses to perform completed by using Contracting Agency or other forces. An emergency situation is any situation when, in the opinion of the Engineer, a delay in its remedy could be potentially unsafe, or might cause serious risk of loss or damage to the public.

Direct or indirect costs incurred by the Contracting Agency attributable to correcting and remedying defective or unauthorized work, or work the Contractor failed or refused to perform, shall be paid by the Contractor. Payment will be deducted by the Engineer from monies due, or to become due, the Contractor. Such direct and indirect costs shall include in particular, but without limitation, compensation for additional professional services required, and costs for repair and replacement of work of others destroyed or damaged by correction, removal, or replacement of the Contractor's unauthorized work.

No adjustment in Contract time or compensation will be allowed because of the delay in the performance of the work attributable to the exercise of the Contracting Agency's rights provided by this section.

The rights exercised under the provisions of this section shall not diminish the Contracting Agency's right to pursue any other avenue for additional remedy or damages with respect to the Contractor's failure to perform the work as required.

### **1-05.11 Final Inspection**

***(October 1, 2005 APWA GSP)***

Delete this section and replace it with the following:

### **1-05.11 Final Inspections and Operational Testing**

#### **1-05.11(1) Substantial Completion Date**

When the Contractor considers the work to be substantially complete, the Contractor shall so notify the Engineer and request the Engineer establish the Substantial Completion Date. The Contractor's request shall list the specific items of work that remain to be completed in order to reach physical completion. The Engineer will schedule an inspection of the work with the Contractor to determine the status of completion. The Engineer may also establish the Substantial Completion Date unilaterally.

If, after this inspection, the Engineer concurs with the Contractor that the work is substantially complete and ready for its intended use, the Engineer, by written notice to the Contractor, will set the Substantial Completion Date. If, after this inspection the Engineer does not consider the work substantially complete and ready for its intended use, the Engineer will, by written notice, so notify the Contractor giving the reasons therefore.

Upon receipt of written notice concurring in or denying substantial completion, whichever is applicable, the Contractor shall pursue vigorously, diligently and without unauthorized interruption, the work necessary to reach Substantial and Physical Completion. The Contractor shall provide the Engineer with a revised schedule indicating when the Contractor expects to reach substantial and physical completion of the work.

The above process shall be repeated until the Engineer establishes the Substantial Completion Date and the Contractor considers the work physically complete and ready for final inspection.

**1-05.11(2) Final Inspection and Physical Completion Date**

When the Contractor considers the work physically complete and ready for final inspection, the Contractor by written notice, shall request the Engineer to schedule a final inspection. The Engineer will set a date for final inspection. The Engineer and the Contractor will then make a final inspection and the Engineer will notify the Contractor in writing of all particulars in which the final inspection reveals the work incomplete or unacceptable. The Contractor shall immediately take such corrective measures as are necessary to remedy the listed deficiencies. Corrective work shall be pursued vigorously, diligently, and without interruption until physical completion of the listed deficiencies. This process will continue until the Engineer is satisfied the listed deficiencies have been corrected.

If action to correct the listed deficiencies is not initiated within 7 days after receipt of the written notice listing the deficiencies, the Engineer may, upon written notice to the Contractor, take whatever steps are necessary to correct those deficiencies pursuant to Section 1-05.7.

The Contractor will not be allowed an extension of Contract time because of a delay in the performance of the work attributable to the exercise of the Engineer's right hereunder.

Upon correction of all deficiencies, the Engineer will notify the Contractor and the Contracting Agency, in writing, of the date upon which the work was considered physically complete. That date shall constitute the Physical Completion Date of the Contract, but shall not imply acceptance of the work or that all the obligations of the Contractor under the Contract have been fulfilled.

**1-05.11(3) Operational Testing**

It is the intent of the Contracting Agency to have at the Physical Completion Date a complete and operable system. Therefore when the work involves the installation of machinery or other mechanical equipment; street lighting, electrical distribution or signal systems; irrigation systems; buildings; or other similar work it may be desirable for the Engineer to have the Contractor operate and test the work for a period of time after final inspection but prior to the physical completion date. Whenever items of work are listed in the Contract Provisions for operational testing they shall be fully tested under operating

conditions for the time period specified to ensure their acceptability prior to the Physical Completion Date. During and following the test period, the Contractor shall correct any items of workmanship, materials, or equipment which prove faulty, or that are not in first class operating condition. Equipment, electrical controls, meters, or other devices and equipment to be tested during this period shall be tested under the observation of the Engineer, so that the Engineer may determine their suitability for the purpose for which they were installed. The Physical Completion Date cannot be established until testing and corrections have been completed to the satisfaction of the Engineer.

The costs for power, gas, labor, material, supplies, and everything else needed to successfully complete operational testing, shall be included in the unit Contract prices related to the system being tested, unless specifically set forth otherwise in the Proposal.

Operational and test periods, when required by the Engineer, shall not affect a manufacturer's guaranties or warranties furnished under the terms of the Contract.

**1-05.12 Final Acceptance**  
***(April 12, 2019 CFW GSP)***

Delete the third and fourth sentences in the first paragraph and replace it with the following:  
Final acceptance date of the work shall be the date the Federal Way City Council accepts the project as complete.

Add the following new section.

**1-05.12(1) One-Year Guarantee Period**  
***(March 8, 2013 APWA GSP)***

The Contractor shall return to the project and repair or replace all defects in workmanship and material discovered within one year after Final Acceptance of the Work. The Contractor shall start work to remedy any such defects within 7 calendar days of receiving Contracting Agency's written notice of a defect, and shall complete such work within the time stated in the Contracting Agency's notice. In case of an emergency, where damage may result from delay or where loss of services may result, such corrections may be made by the Contracting Agency's own forces or another contractor, in which case the cost of corrections shall be paid by the Contractor. In the event the Contractor does not accomplish corrections within the time specified, the work will be otherwise accomplished and the cost of same shall be paid by the Contractor.

When corrections of defects are made, the Contractor shall then be responsible for correcting all defects in workmanship and materials in the corrected work for one year after acceptance of the corrections by Contracting Agency.

This guarantee is supplemental to and does not limit or affect the requirements that the Contractor's work comply with the requirements of the Contract or any other legal rights or remedies of the Contracting Agency.

**1-05.13 Superintendents, Labor and Equipment of Contractor**  
***(August 14, 2013 APWA GSP)***

Delete the sixth and seventh paragraphs of this section.

**1-05.15 Method of Serving Notices**  
***(March 25, 2009 APWA GSP)***

Revise the second paragraph to read:

All correspondence from the Contractor shall be directed to the Project Engineer. All correspondence from the Contractor constituting any notification, notice of protest, notice of dispute, or other correspondence constituting notification required to be furnished under the Contract, must be in paper format, hand delivered or sent via mail delivery service to the Project Engineer's office. Electronic copies such as e-mails or electronically delivered copies of correspondence will not constitute such notice and will not comply with the requirements of the Contract.

Add the following new section:

**1-05.16 Water and Power**  
**(October 1, 2005 APWA GSP)**

The Contractor shall make necessary arrangements, and shall bear the costs for power and water necessary for the performance of the work, unless the Contract includes power and water as a pay item.

**1-05.18 Contractor's Daily Diary**  
**(April 12, 2018 CFW GSP)**

Section 1-05.18 is a new section:

The Contractor and subcontractors, as additional consideration for payment for this contract work, hereby agree to maintain and provide to the Owner and the Engineer a Daily Diary Record of this Work. The diary must be kept and maintained by the Contractor's designated project superintendent. Entries must be made on a daily basis and must accurately represent all of the project activities on each day.

At a minimum, the diary shall show on a daily basis:

- The day and date.
- The weather conditions, including changes throughout the day.
- A complete description of work accomplished during the day with adequate references to the Plans and Specifications so that the reader can easily and accurately identify said work on the Plans.
- An entry for each and every changed condition, dispute or potential dispute, incident, accident, or occurrence of any nature whatsoever which might affect the Contract, Owner, or any third party in any manner.
- Listing of any materials received and stored on or off-site by the Contractor for future installation, to include the manner of storage and protection of the same.
- Listing of materials installed during each day.
- List of all subcontractors working on-site during each day.
- Listing of the number of Contractor's employees working during each day by category of employment.
- Listing of Contractor's equipment working on the site during each day. Idle equipment on the site shall be listed and designated as idle.
- Notations to explain inspections, testing, stake-out, and all other services furnished to the Contractor by the Owner or other during each day.
- Entries to verify the daily (including non-work days) inspection and maintenance of traffic control devices and condition of the traveled roadway surfaces. The Contractor shall not allow any conditions to develop that would be hazardous to the public.
- Any other information that serves to give an accurate and complete record of the nature, quantity, and quality of the Contractor's progress on each day.

- Summary of total number of working days to date, and total number of delay days to date.

The Contractor's designated project superintendent must sign the diary at the end of each working day. The Contractor must provide a copy of the diary to the Owner and the Engineer each morning for the preceding workday. All copies must be legible.

It is expressly agreed between the contractor and the owner that the daily diary maintained by the Contractor shall be the "Contractor's Book of Original Entry" for the documentation of any potential claims or disputes that might arise during this contract. Failure of the Contractor to maintain this diary in the manner described above will constitute a waiver of any such claims or disputes by the Contractor. The daily diary maintained by the Contractor does not constitute the official record of the project. The official record of the project is prepared and maintained exclusively by the engineer.

**1-05.19 Defects Arising in One Year and Remedies**  
***(February 15, 2019 CFW GSP)***

Section 1-05.19 is a new section:

The Contractor shall, at its own sole cost and expense, be responsible for correcting all defects in workmanship and material discovered within one year after acceptance of this work by the City of Federal Way. When corrections of defects are made, the Contractor shall be responsible for correcting all defects in workmanship and/or materials in the corrected work for one year after acceptance of the corrections by the Owner. Conducting of tests and inspections, review of specifications or plans, payment for goods or services, or acceptance by the City does not constitute waiver, modification, or exclusion of any express or implied warranty or any right under law. This warranty shall survive termination of this Contract.

The Contractor shall start work to remedy such defects within seven (7) calendar days of mailing notice of discovery thereof by the Owner and shall complete such work within a reasonable time. In emergencies, where damage may result from delay or where loss of services may result, such corrections may be made by the Owner, in which case the cost shall be borne by the Contractor. In the event the Contractor does not accomplish corrections at the time specified, the work will be otherwise accomplished and the cost of same shall be paid by the Contractor. These actions will be pursuant to the provisions of Section 1-05.8 of the Standard Specifications.

The Contractor shall be liable for any costs, losses, expenses, or damages, including consequential damages suffered by the Owner resulting from defects in the Contractor's work including, but not limited to, cost of materials and labor extended by Owner in making emergency repairs and cost of engineering, inspection and supervision by the Owner or the Engineer. The Contractor shall hold the Owner harmless from any and all claims which may be made against the Owner as a result of any defective work, and the Contractor shall defend any such claims at his own expense.

The Contractor agrees the above one-year limitation shall not exclude or diminish the Owner's rights under any law to obtain damages and recover costs resulting from defective and unauthorized work discovered after one year but prior to the expiration of the legal time period set forth in RCW 9.16.040 limiting actions upon a contract in writing or liability, expressed or implied, arising out of a written agreement. This warranty may also extend beyond the one year time period pursuant to any other warranties specified in



the Special Provisions, Contract Plans, other parts of the Contract Documents, or incorporated by this reference.

## **1-06 CONTROL OF MATERIAL**

### **1-06.6 Recycled Materials**

***(January 4, 2016 APWA GSP)***

Delete this section, including its subsections, and replace it with the following:

The Contractor shall make their best effort to utilize recycled materials in the construction of the project. Approval of such material use shall be as detailed elsewhere in the Standard Specifications.

Prior to Physical Completion the Contractor shall report the quantity of recycled materials that were utilized in the construction of the project for each of the items listed in Section 9-03.21. The report shall include hot mix asphalt, recycled concrete aggregate, recycled glass, steel furnace slag and other recycled materials (e.g. utilization of on-site material and aggregates from concrete returned to the supplier). The Contractor's report shall be provided on DOT form 350-075 Recycled Materials Reporting.

## **1-07 LEGAL RELATIONS AND RESPONSIBILITIES TO THE PUBLIC**

### **1-07.1 Laws to be Observed**

***(October 1, 2005 APWA GSP)***

Supplement this section with the following:

In cases of conflict between different safety regulations, the more stringent regulation shall apply.

The Washington State Department of Labor and Industries shall be the sole and paramount administrative agency responsible for the administration of the provisions of the Washington Industrial Safety and Health Act of 1973 (WISHA).

The Contractor shall maintain at the project site office, or other well-known place at the project site, all articles necessary for providing first aid to the injured. The Contractor shall establish, publish, and make known to all employees, procedures for ensuring immediate removal to a hospital, or doctor's care, persons, including employees, who may have been injured on the project site. Employees should not be permitted to work on the project site before the Contractor has established and made known procedures for removal of injured persons to a hospital or a doctor's care.

The Contractor shall have sole responsibility for the safety, efficiency, and adequacy of the Contractor's Plant, appliances, and methods, and for any damage or injury resulting from their failure, or improper maintenance, use, or operation. The Contractor shall be solely and completely responsible for the conditions of the project site, including safety for all persons and property in the performance of the work. This requirement shall apply continuously, and not be limited to normal working hours. The required or implied duty of the Engineer to conduct construction review of the Contractor's performance does not, and shall not, be intended to include review and adequacy of the Contractor's safety measures in, on, or near the project site.

Section 1-07.1 is supplemented with the following:

**(April 12, 2019 CFW GSP)**

**Confined Space**

Confined spaces are known to exist at the following locations:

Existing storm drainage, sanitary sewer, and other utility systems, vaults, and structures, along with all new similar new construction items that meet the requirements of WAC 296-809-100.

The Contractor shall be fully responsible for the safety and health of all on-site workers and compliant with Washington Administrative Code (WAC 296-809).

The Contractor shall prepare and implement a confined space program for each of the confined spaces identified above. The Contractors Confined Space program shall be sent to the contracting agency at least 5 days prior to the Contractor beginning work in or adjacent to the confined space. No work shall be performed in or adjacent to the confined space until the plan is submitted to the Engineer as required. The Contractor shall communicate with the Engineer to ensure a coordinated effort for providing and maintaining a safe worksite for both the Contracting Agency's and Contractor's workers when working in or near a confined space.

All costs to prepare and implement the confined space program shall be included in the bid prices for the various items associated with the confined space work.

**1-07.2 State Taxes**

Delete this section, including its sub-sections, in its entirety and replace it with the following:

**1-07.2 State Sales Tax**

**(June 27, 2011 APWA GSP)**

The Washington State Department of Revenue has issued special rules on the State sales tax. Sections 1-07.2(1) through 1-07.2(3) are meant to clarify those rules. The Contractor should contact the Washington State Department of Revenue for answers to questions in this area. The Contracting Agency will not adjust its payment if the Contractor bases a Bid on a misunderstood tax liability.

The Contractor shall include all Contractor-paid taxes in the unit Bid prices or other Contract amounts. In some cases, however, state retail sales tax will not be included. Section 1-07.2(2) describes this exception.

The Contracting Agency will pay the retained percentage (or release the Contract Bond if a FHWA-funded Project) only if the Contractor has obtained from the Washington State Department of Revenue a certificate showing that all Contract-related taxes have been paid (RCW 60.28.051). The Contracting Agency may deduct from its payments to the Contractor any amount the Contractor may owe the Washington State Department of Revenue, whether the amount owed relates to this Contract or not. Any amount so deducted will be paid into the proper State fund.

**1-07.2(1) State Sales Tax — Rule 171**

WAC 458-20-171, and its related rules, apply to building, repairing, or improving streets, roads, etc., which are owned by a municipal corporation, or political subdivision of the state, or by the United States, and which are used primarily for foot or vehicular traffic. This includes storm or combined sewer systems within

and included as a part of the street or road drainage system and power lines when such are part of the roadway lighting system. For work performed in such cases, the Contractor shall include Washington State Retail Sales Taxes in the various unit Bid item prices, or other Contract amounts, including those that the Contractor pays on the purchase of the materials, equipment, or supplies used or consumed in doing the work.

### **1-07.2(2) State Sales Tax — Rule 170**

WAC 458-20-170, and its related rules, apply to the constructing and repairing of new or existing buildings, or other structures, upon real property. This includes, but is not limited to, the construction of streets, roads, highways, etc., owned by the state of Washington; water mains and their appurtenances; sanitary sewers and sewage disposal systems unless such sewers and disposal systems are within, and a part of, a street or road drainage system; telephone, telegraph, electrical power distribution lines, or other conduits or lines in or above streets or roads, unless such power lines become a part of a street or road lighting system; and installing or attaching of any article of tangible personal property in or to real property, whether or not such personal property becomes a part of the realty by virtue of installation.

For work performed in such cases, the Contractor shall collect from the Contracting Agency, retail sales tax on the full Contract price. The Contracting Agency will automatically add this sales tax to each payment to the Contractor. For this reason, the Contractor shall not include the retail sales tax in the unit Bid item prices, or in any other Contract amount subject to Rule 170, with the following exception.

Exception: The Contracting Agency will not add in sales tax for a payment the Contractor or a subcontractor makes on the purchase or rental of tools, machinery, equipment, or consumable supplies not integrated into the project. Such sales taxes shall be included in the unit Bid item prices or in any other Contract amount.

### **1-07.2(3) Services**

The Contractor shall not collect retail sales tax from the Contracting Agency on any Contract wholly for professional or other services (as defined in Washington State Department of Revenue Rules 138 and 244).

### ***(December 16, 2022 CFW GSP)***

Section 1-07.6 is supplemented with the following:

#### **Oversized Loads**

The Contractor must obtain a permit from the City of Federal Way (Development Services Division) for any Oversize / Overweight Loads. Loads are classified as oversized / overweight if they exceed the following criteria:

#### Size

- 8'6" wide, 14' tall, 53' length (tractor/trailer)
- 40' single unit
- 75' overall with a truck and trailer
- 3' of front overhang and 15' of rear overhang

#### Weight

- Heavy loads require a permit for overweight if they exceed the vehicle weight table published by WSDOT. The gross vehicle weight for a vehicle or a vehicle combination is determined by an overlapping set of three criteria: tire size, axle weight, and the weight table.

**1-07.4 Sanitation**

**1-07.4(2) Health Hazards**

***(January 10, 2023 CFW PROJECT SPECIFIC GSP)***

Section 1-07.4(2) is supplemented with the following:

This project site is known to have been occupied by transients in the past and therefore may contain biological hazards and associated physical hazards. These may include, but not be limited to, hypodermic needles, garbage, broken glass, human and animal excrement, drug paraphernalia, and other hazards.

The contractor shall ensure that the public, including persons who may be non-English speaking or those who may not be able to recognize potential safety and health hazards within the project area, are not harmed by the Contractors activities.

**1-07.17 Utilities and Similar Facilities**

***(April 2, 2007 WSDOT GSP, OPTION 1)***

Section 1-07.17 is supplemented with the following:

Locations and dimensions shown in the Plans for existing facilities are in accordance with available information obtained without uncovering, measuring, or other verification.

The following addresses and telephone numbers of utility companies known or suspected of having facilities within the project limits are supplied for the Contractor’s convenience.

**UTILITY CONTACTS**

**Puget Sound Energy (Power)**

Attn: Jason Airey  
3130 S 38<sup>th</sup> St  
Tacoma, WA 98409  
Telephone: (206) 348-9637

**Lumen**

Attn: Tanaiya Anderson  
23315 66th Ave S  
Kent, WA 98032  
Tanaiya.Anderson@lumen.com  
Telephone: (253) 313-8961

**Puget Sound Energy (Gas)**

Attn: Katie Dierick  
Katie.Dierick@pse.com  
Cell: (253) 268-6331

**Comcast**

Attn: Kyle Kinney  
410 Valley Ave NW  
Puyallup, WA 98371  
Kyle\_Kinney@comcast.com  
Telephone: (253) 293-3838

**Lakehaven Water & Sewer District**

Attn: Naveen Chandra, P.E.  
31623 1<sup>st</sup> Avenue S  
Federal Way, WA 98063-4249  
NChandra@lakehaven.org  
Telephone: (253) 946-5440  
Cell: (206) 966-8185

**AT&T**

Attn: Steve Duppenhaler  
11241 Willows Rd NE, #130  
Redmond, WA 98052  
Telephone: (425)286-3822

**Zayo**

Attn: Jason Tesdal  
4905 Pacific Hwy E, Suite 4  
Fife, WA 98424  
Jason.Tesdal@zayo.com  
Telephone: (253) 221-7585

**City of FW IT Dept (City Fiber)**

Attn: Thomas Fichtner  
33325 8th Ave S  
Federal Way, WA 98003  
Telephone: (253) 835-2547

**King Co. Traffic (Signals & Lighting)**

Attn: Mark Parrett  
155 Monroe Ave NE  
Renton, WA 98056  
Telephone: (206) 296-8153

**ADDITIONAL CONTACTS**

**King County Metro Transit**

81270 6th Ave S, Bldg 2  
Seattle, WA 98134  
Telephone: (206) 684-2785

**South King Fire & Rescue**

31617 1st Ave S  
Federal Way, WA 98003  
Telephone: (253) 946-7253

**City of Federal Way Police**

33325 8th Ave S  
Federal Way, WA 98003  
Telephone: (253) 835-6701  
(for officer traffic control scheduling)  
Telephone: (253) 835-6767  
(for traffic / road closure issues)

**Federal Way School District**

Attn: Transportation Department  
1211 S. 332nd St  
Federal Way, WA 98003  
Telephone: (253) 945-5960

**1-07.18 Public Liability and Property Damage Insurance**

Delete this section in its entirety, and replace it with the following:

**1-07.18 Insurance**

***(January 4, 2016 APWA GSP)***

**1-07.18(1) General Requirements**

- A. The Contractor shall procure and maintain the insurance described in all subsections of section 1-07.18 of these Special Provisions, from insurers with a current A. M. Best rating of not less than A-: VII and licensed to do business in the State of Washington. The Contracting Agency reserves the right to approve or reject the insurance provided, based on the insurer's financial condition.
- B. The Contractor shall keep this insurance in force without interruption from the commencement of the Contractor's Work through the term of the Contract and for thirty (30) days after the Physical Completion date, unless otherwise indicated below.
- C. If any insurance policy is written on a claims made form, its retroactive date, and that of all subsequent renewals, shall be no later than the effective date of this Contract. The policy shall state that coverage is claims made, and state the retroactive date. Claims-made form coverage shall be maintained by the Contractor for a minimum of 36 months following the Completion Date or earlier termination of this Contract, and the Contractor

shall annually provide the Contracting Agency with proof of renewal. If renewal of the claims made form of coverage becomes unavailable, or economically prohibitive, the Contractor shall purchase an extended reporting period ("tail") or execute another form of guarantee acceptable to the Contracting Agency to assure financial responsibility for liability for services performed.

- D. The Contractor's Automobile Liability, Commercial General Liability and Excess or Umbrella Liability insurance policies shall be primary and non-contributory insurance as respects the Contracting Agency's insurance, self-insurance, or self-insured pool coverage. Any insurance, self-insurance, or self-insured pool coverage maintained by the Contracting Agency shall be excess of the Contractor's insurance and shall not contribute with it.
- E. The Contractor shall provide the Contracting Agency and all additional insureds with written notice of any policy cancellation, within two business days of their receipt of such notice.
- F. The Contractor shall not begin work under the Contract until the required insurance has been obtained and approved by the Contracting Agency
- G. Failure on the part of the Contractor to maintain the insurance as required shall constitute a material breach of contract, upon which the Contracting Agency may, after giving five business days' notice to the Contractor to correct the breach, immediately terminate the Contract or, at its discretion, procure or renew such insurance and pay any and all premiums in connection therewith, with any sums so expended to be repaid to the Contracting Agency on demand, or at the sole discretion of the Contracting Agency, offset against funds due the Contractor from the Contracting Agency.
- H. All costs for insurance shall be incidental to and included in the unit or lump sum prices of the Contract and no additional payment will be made.

**1-07.18(2) Additional Insured**

All insurance policies, with the exception of Workers Compensation, and of Professional Liability and Builder's Risk (if required by this Contract) shall name the following listed entities as additional insured(s) using the forms or endorsements required herein:

- The Contracting Agency and its officers, elected officials, employees, agents, and volunteers.
- The consultant that completed the preparation of the engineering design and project plans, and its officers, employees, agents, and subconsultants.
- Consultants hired by the Contracting Agency for design, construction support, or materials testing.

The above-listed entities shall be additional insured(s) for the full available limits of liability maintained by the Contractor, irrespective of whether such limits maintained by the Contractor are greater than those required by this Contract, and irrespective of whether the Certificate of Insurance provided by the Contractor pursuant to 1-07.18(4) describes limits lower than those maintained by the Contractor.

For Commercial General Liability insurance coverage, the required additional insured endorsements shall be at least as broad as ISO forms CG 20 10 10 01 for ongoing operations and CG 20 37 10 01 for completed operations.

### **1-07.18(3) Subcontractors**

The Contractor shall cause each Subcontractor of every tier to provide insurance coverage that complies with all applicable requirements of the Contractor-provided insurance as set forth herein, except the Contractor shall have sole responsibility for determining the limits of coverage required to be obtained by Subcontractors.

The Contractor shall ensure that all Subcontractors of every tier add all entities listed in 1-07.18(2) as additional insureds, and provide proof of such on the policies as required by that section as detailed in 1-07.18(2) using an endorsement as least as broad as ISO CG 20 10 10 01 for ongoing operations and CG 20 37 10 01 for completed operations.

Upon request by the Contracting Agency, the Contractor shall forward to the Contracting Agency evidence of insurance and copies of the additional insured endorsements of each Subcontractor of every tier as required in 1-07.18(4) Verification of Coverage.

### **1-07.18(4) Verification of Coverage**

The Contractor shall deliver to the Contracting Agency a Certificate(s) of Insurance and endorsements for each policy of insurance meeting the requirements set forth herein when the Contractor delivers the signed Contract for the work. Failure of Contracting Agency to demand such verification of coverage with these insurance requirements or failure of Contracting Agency to identify a deficiency from the insurance documentation provided shall not be construed as a waiver of Contractor's obligation to maintain such insurance.

Verification of coverage shall include:

1. An ACORD certificate or a form determined by the Contracting Agency to be equivalent.
2. Copies of all endorsements naming Contracting Agency and all other entities listed in 1-07.18(2) as additional insured(s), showing the policy number. The Contractor may submit a copy of any blanket additional insured clause from its policies instead of a separate endorsement.
3. Any other amendatory endorsements to show the coverage required herein.
4. A notation of coverage enhancements on the Certificate of Insurance shall not satisfy these requirements – actual endorsements must be submitted.

Upon request by the Contracting Agency, the Contractor shall forward to the Contracting Agency a full and certified copy of the insurance policy(s). If Builders Risk insurance is required on this Project, a full and certified copy of that policy is required when the Contractor delivers the signed Contract for the work.

### **1-07.18(5) Coverages and Limits**

The insurance shall provide the minimum coverages and limits set forth below. Contractor's maintenance of insurance, its scope of coverage, and limits as required herein shall not be construed to limit the liability of the Contractor to the coverage provided by such insurance, or otherwise limit the Contracting Agency's recourse to any remedy available at law or in equity.

All deductibles and self-insured retentions must be disclosed and are subject to approval by the Contracting Agency. The cost of any claim payments falling within the deductible

or self-insured retention shall be the responsibility of the Contractor. In the event an additional insured incurs a liability subject to any policy's deductibles or self-insured retention, said deductibles or self-insured retention shall be the responsibility of the Contractor.

**1-07.18(5)A Commercial General Liability**

Commercial General Liability insurance shall be written on coverage forms at least as broad as ISO occurrence form CG 00 01, including but not limited to liability arising from premises, operations, stop gap liability, independent contractors, products-completed operations, personal and advertising injury, and liability assumed under an insured contract. There shall be no exclusion for liability arising from explosion, collapse or underground property damage.

The Commercial General Liability insurance shall be endorsed to provide a per project general aggregate limit, using ISO form CG 25 03 05 09 or an equivalent endorsement.

Contractor shall maintain Commercial General Liability Insurance arising out of the Contractor's completed operations for at least three years following Substantial Completion of the Work.

Such policy must provide the following minimum limits:

\$1,000,000	Each Occurrence
\$2,000,000	General Aggregate
\$2,000,000	Products & Completed Operations Aggregate
\$1,000,000	Personal & Advertising Injury each offense
\$1,000,000	Stop Gap / Employers' Liability each Accident

***(August 27, 2021 CFW GSP)***

*The Commercial General Liability minimum coverage limit, per each occurrence shown in Section 1-07.18(5)A of the APWA Special Provision included herein is modified as follows:*

*The minimum limit for Commercial General Liability Insurance, per each occurrence shall be \$2,000,000.*

***(January 4, 2016 APWA GSP, cont.)***

**1-07.18(5)B Automobile Liability**

Automobile Liability shall cover owned, non-owned, hired, and leased vehicles; and shall be written on a coverage form at least as broad as ISO form CA 00 01. If the work involves the transport of pollutants, the automobile liability policy shall include MCS 90 and CA 99 48 endorsements.

Such policy must provide the following minimum limit:

\$1,000,000	Combined single limit each accident
-------------	-------------------------------------

**1-07.18(5)C Workers' Compensation**

The Contractor shall comply with Workers' Compensation coverage as required by the Industrial Insurance laws of the State of Washington.

**1-07.18(5)D Excess or Umbrella Liability**

***(January 4, 2016 APWA GSP)***

The Contractor shall provide Excess or Umbrella Liability insurance with limits of not less than \$3,000,000 each occurrence and annual aggregate. This excess or umbrella liability



coverage shall be excess over and as least as broad in coverage as the Contractor's Commercial General and Auto Liability insurance.

All entities listed under 1-07.18(2) of these Special Provisions shall be named as additional insureds on the Contractor's Excess or Umbrella Liability insurance policy.

This requirement may be satisfied instead through the Contractor's primary Commercial General and Automobile Liability coverages, or any combination thereof that achieves the overall required limits of insurance.

**1-07.18(5)J Pollution Liability**  
**(January 4, 2016 APWA GSP)**

The Contractor shall provide a Contractors Pollution Liability policy, providing coverage for claims involving bodily injury, property damage (including loss of use of tangible property that has not been physically injured), cleanup costs, remediation, disposal or other handling of pollutants, including costs and expenses incurred in the investigation, defense, or settlement of claims, arising out of any one or more of the following:

1. Contractor's operations related to this project.
2. Remediation, abatement, repair, maintenance or other work with lead-based paint or materials containing asbestos.
3. Transportation of hazardous materials away from any site related to this project.

All entities listed under 1-07.18(2) of these Special Provisions shall be named by endorsement as additional insureds on the Contractors Pollution Liability insurance policy.

Such Pollution Liability policy shall provide the following minimum limits:  
\$2,000,000 each loss and annual aggregate

**1-07.23 Public Convenience and Safety**

**(October 3, 2022 WSDOT GSP, OPTION 5)**

Section 1-07.23(1) is supplemented with the following:

Lane, ramp, shoulder, and roadway closures are subject to the following restrictions:

- The Contractor shall, at all times throughout the project, conduct the work in such a manner as will obstruct and inconvenience vehicular and pedestrian traffic as little as possible. The streets, sidewalks and private driveways shall be kept open by the Contractor except for the brief periods when actual work is being done. The Contractor shall conduct his operations so as to have under construction no greater length or amount of work than he can prosecute vigorously and he shall not open up sections of the work and leave them in an unfinished condition.
- The Contractor shall provide flaggers, signs, and other traffic control devices. The Contractor shall erect and maintain all construction signs, warning signs, detour signs, and other traffic control devices necessary to warn and protect the public at all times from injury or damage as a result of the Contractor's operations which may occur on highways, roads, streets, sidewalks, or paths. No work shall be done on or adjacent to

any traveled way until all necessary signs and traffic control devices are in place.

- All signs and traffic control devices for the permitted closures shall only be installed during the specified hours. Construction signs, if placed earlier than the specified hours of closure, shall be turned or covered so as not to be visible to motorists
- The Contractor shall keep all pedestrian routes & access points (including, but not limited to, sidewalks, and crosswalks when located within the project limits) open and clear at all times unless permitted otherwise by the Engineer in an approved traffic control plan. An ADA accessible route must be provided through the project site at all times.
- Pedestrians must have access to pedestrian push buttons at all times.
- Lane closures shall not impact business access. All businesses shall remain accessible by vehicles and pedestrian during business hours.
- Lane closures shall not restrict vehicular access for buses through the project site. Bus stops shall remain ADA accessible to pedestrians at all times throughout the project.
- The Contractor shall be responsible for notifying all affected property owners and tenants prior to commencing the barricading of streets, alleys, sidewalks and driveways. Notifications should be at least 48 hours in advance of closures, if possible.
- No paving shall occur in residential areas during refuse, recycle, and yard waste collection days. Collection schedules are available at [www.cityoffederalway.com/publicworks/recycling](http://www.cityoffederalway.com/publicworks/recycling).
- For approved night work, it shall be the Contractor's responsibility to obtain any required noise variance or exemption for such work.
- For approved night work, the Contractor shall, at no additional cost to the City, make all arrangements for operations during hours of darkness. Flagger stations shall be illuminated using a minimum 150-watt floodlight. Lighting used for nighttime work shall, whenever possible, be directed away from or shielded from residences and oncoming traffic. Signs and barricades shall be supplemented by Type C steady burn lights to delineate edge of roadway during the hours of darkness.
- The Contractor may, if shown on a traffic control plan approved by the Engineer, momentarily interrupt continuous two-way traffic to allow one-way traffic (alternating directions / flagger controlled). Such interruptions shall utilize qualified flaggers placed in strategic locations to insure the public safety and minimize driver confusion.

- For projects with bid schedules located in multiple locations throughout the City, the Contractor shall not have personnel or subcontractors working on-site at more than two schedules at any given time.

If the Engineer determines the permitted closure hours adversely affect traffic, the Engineer may adjust the hours accordingly. The Engineer will notify the Contractor in writing of any change in the closure hours. Exceptions to these restrictions may be considered by the Engineer on a case-by-case basis following a written request by the Contractor.

Lane, ramp, shoulder, and roadway closures are not allowed on any of the following:

1. A holiday,
2. A holiday weekend; holidays that occur on Friday, Saturday, Sunday or Monday are considered a holiday weekend. A holiday weekend includes Saturday, Sunday, and the holiday.
3. After 12:00 PM (noon) on the day prior to a holiday or holiday weekend, and
4. Before 7:00 AM on the day after the holiday or holiday weekend.
5. Within the City Center zone from the Friday after Thanksgiving Day (“Black Friday”) until the first City recognized business day of the following year without written approval by the Engineer. The boundaries of the City Center zone are identified in the City of Federal Way Comprehensive Plan. In general, it is the area located within the following boundaries:

Northern boundary: S 312th Street  
 Southern boundary: S 324th Street  
 Eastern boundary: Interstate 5  
 Western boundary: 14th Ave S (future extension) / Federal Way  
 320<sup>th</sup> Library / 11th PI S

**Traffic Delays**

When Automated Flagger Assistance Devices (AFADs) or flaggers are used to control traffic, traffic shall not be stopped for more than two minutes at any time. All traffic congestion shall be allowed to clear before traffic is delayed again.

If the delay becomes greater than two minutes, the Contractor shall immediately begin to take action to cease the operations that are causing the delays. If the two minute delay limit has been exceeded, as determined by the Engineer, the Contractor shall provide to the Engineer, a written proposal to revise his work operations to meet the two minute limit. This proposal shall be accepted by the Engineer prior to resuming any work requiring traffic control.

There shall be no delay to medical, fire, or other emergency vehicles. The Contractor shall alert all flaggers and personnel of this requirement.

**General Restrictions**

Construction vehicles using a closed traffic lane shall travel only in the normal direction of traffic flow unless expressly allowed in an accepted traffic control plan. Construction vehicles shall be equipped with flashing or rotating amber lights.

No two consecutive on-ramps, off-ramps, or intersections shall be closed at the same time and only one ramp at an interchange shall be closed, unless specifically shown in the Plans.

Roads or ramps that are designated as part of a detour shall not be closed or restricted during the implementation of that detour, unless specifically shown in the Plans.

### **Controlled Access**

No special access or egress shall be allowed by the Contractor other than normal legal movements or as shown in the Plans.

Contractor's vehicles of 10,000 GVW or greater shall not exit or enter a lane open to public traffic except as follows:

Egress and ingress shall only occur during the hours of allowable lane closures, and:

1. For exiting an open lane of traffic, by decelerating in a lane that is closed during the allowable hours for lane closures.
2. For entering an open lane of traffic, by accelerating in a closed lane during the allowable hours for lane closures.

### **Advance Notification**

The Contractor shall notify the Engineer in writing of any traffic impacts related to lane closure, shoulder closure, sidewalk closure, or any combination for the week by 12:00 p.m. (noon) Wednesday the week prior to the stated impacts.

The Contractor shall notify the Engineer in writing ten working days in advance of any traffic impacts related to full roadway closure, ramp closure, or both.

The Contractor shall notify the Engineer in writing of any changes to the stated traffic impacts a minimum of 48 hours prior to the traffic impacts.

### **1-07.24 Rights of Way** ***(July 23, 2015 APWA GSP)***

Delete this section and replace it with the following:

Street Right of Way lines, limits of easements, and limits of construction permits are indicated in the Plans. The Contractor's construction activities shall be confined within these limits, unless arrangements for use of private property are made.

Generally, the Contracting Agency will have obtained, prior to bid opening, all rights of way and easements, both permanent and temporary, necessary for carrying out the work. Exceptions to this are noted in the Bid Documents or will be brought to the Contractor's attention by a duly issued Addendum.

Whenever any of the work is accomplished on or through property other than public Right of Way, the Contractor shall meet and fulfill all covenants and stipulations of any easement agreement obtained by the Contracting Agency from the owner of the private property. Copies of the easement agreements may be included in the Contract Provisions or made available to the Contractor as soon as practical after they have been obtained by the Engineer.

Whenever easements or rights of entry have not been acquired prior to advertising, these areas are so noted in the Plans. The Contractor shall not proceed with any portion of the work in areas where right of way, easements or rights of entry have not been acquired until the Engineer certifies to the Contractor that the right of way or easement is available or that the right of entry has been received. If the Contractor is delayed due to acts of omission on the part of the Contracting Agency in obtaining easements, rights of entry or right of way, the Contractor will be entitled to an extension of time. The Contractor agrees that such delay shall not be a breach of contract.

Each property owner shall be given 48 hours notice prior to entry by the Contractor. This includes entry onto easements and private property where private improvements must be adjusted.

The Contractor shall be responsible for providing, without expense or liability to the Contracting Agency, any additional land and access thereto that the Contractor may desire for temporary construction facilities, storage of materials, or other Contractor needs. However, before using any private property, whether adjoining the work or not, the Contractor shall file with the Engineer a written permission of the private property owner, and, upon vacating the premises, a written release from the property owner of each property disturbed or otherwise interfered with by reasons of construction pursued under this contract. The statement shall be signed by the private property owner, or proper authority acting for the owner of the private property affected, stating that permission has been granted to use the property and all necessary permits have been obtained or, in the case of a release, that the restoration of the property has been satisfactorily accomplished. The statement shall include the parcel number, address, and date of signature. Written releases must be filed with the Engineer before the Completion Date will be established.

## **1-08 PROSECUTION AND PROGRESS**

Add the following new section:

### **1-08.0 Preliminary Matters** ***(May 25, 2006 APWA GSP)***

#### **1-08.0(1) Preconstruction Conference** ***(October 10, 2008 APWA GSP)***

Prior to the Contractor beginning the work, a preconstruction conference will be held between the Contractor, the Engineer, and such other interested parties as may be invited. The purpose of the preconstruction conference will be:

1. To review the initial progress schedule;
2. To establish a working understanding among the various parties associated or affected by the work;

3. To establish and review procedures for progress payment, notifications, approvals, submittals, etc.;
4. To establish normal working hours for the work;
5. To review safety standards and traffic control; and
6. To discuss such other related items as may be pertinent to the work.

The Contractor shall prepare and submit at the preconstruction meeting the following:

1. A breakdown of all lump sum items;
2. A preliminary schedule of working drawing submittals; and
3. A list of material sources for approval if applicable.

**1-08.0(2) Hours of Work**  
***(December 8, 2014 APWA GSP)***

Add the following new section:

Except in the case of emergency or unless otherwise approved by the Engineer, the normal working hours for the Contract shall be any consecutive 8-hour period between 7:00 a.m. and 6:00 p.m. Monday through Friday, exclusive of a lunch break. If the Contractor desires different than the normal working hours stated above, the request must be submitted in writing prior to the preconstruction conference, subject to the provisions below. The working hours for the Contract shall be established at or prior to the preconstruction conference.

All working hours and days are also subject to local permit and ordinance conditions (such as noise ordinances).

If the Contractor wishes to deviate from the established working hours, the Contractor shall submit a written request to the Engineer for consideration. This request shall state what hours are being requested, and why. Requests shall be submitted for review no later than noon two working days prior to the day(s) the Contractor is requesting to change the hours.

If the Contracting Agency approves such a deviation, such approval may be subject to certain other conditions, which will be detailed in writing. For example:

1. On non-Federal aid projects, requiring the Contractor to reimburse the Contracting Agency for the costs in excess of straight-time costs for Contracting Agency representatives who worked during such times. (The Engineer may require designated representatives to be present during the work. Representatives who may be deemed necessary by the Engineer include, but are not limited to: survey crews; personnel from the Contracting Agency's material testing lab; inspectors; and other Contracting Agency employees or third party consultants when, in the opinion of the Engineer, such work necessitates their presence.)
2. Considering the work performed on Saturdays, Sundays, and holidays as working days with regard to the contract time.

3. Considering multiple work shifts as multiple working days with respect to contract time even though the multiple shifts occur in a single 24-hour period.
4. If a 4-10 work schedule is requested and approved the non-working day for the week will be charged as a working day.
5. If Davis Bacon wage rates apply to this Contract, all requirements must be met and recorded properly on certified payroll.

***(December 1, 2021 CFW GSP)***

Add the following new section:

The Contractor may request extended work hours on days when paving operations are occurring. Work hours may be modified to 7:00 a.m. to 5:30 p.m. on paving days if the Engineer determines that the benefits of extended working hours will minimize the overall impacts to traffic. Extended work hours for paving will require PCMS boards to be placed a minimum of 2 business days prior to the paving day. Payment for PCMS boards shall be considered incidental to the Contractor's operations, unless there is a specific bid item for PCMS boards.

**1-08.1 Subcontracting**

***(May 30, 2019 APWA GSP, OPTION B)***

Delete the ninth paragraph, beginning with "On all projects, the Contractor shall certify...".

**1-08.3 Progress Schedule**

**1-08.3(1) General Requirements**

***(October 3, 2022 WSDOT GSP, OPTION 2)***

Section 1-08.3(1) is supplemented with the following:

In addition to information required in Items 1 through 6, the Progress Schedule shall include the following milestones and/or activities:

7. Materials requiring long procurement or fabrication periods, such as signal or light poles, structural elements, or mechanical items.

**1-08.3(2)A Type A Progress Schedule**

***(March 13, 2012 APWA GSP)***

Revise this section to read:

The Contractor shall submit 2 copies of a Type A Progress Schedule no later than at the preconstruction conference, or some other mutually agreed upon submittal time. The schedule may be a critical path method (CPM) schedule, bar chart, or other standard schedule format. Regardless of which format used, the schedule shall identify the critical path. The Engineer will evaluate the Type A Progress Schedule and approve or return the schedule for corrections within 15 calendar days of receiving the submittal.

**1-08.4 Prosecution of Work**

Delete this section and replace it with the following:

**1-08.4 Notice to Proceed and Prosecution of Work**

***(July 23, 2015 APWA GSP)***

Notice to Proceed will be given after the contract has been executed and the contract bond and evidence of insurance have been approved and filed by the Contracting Agency. The

Contractor shall not commence with the work until the Notice to Proceed has been given by the Engineer. The Contractor shall commence construction activities on the project site within ten days of the Notice to Proceed Date, unless otherwise approved in writing. The Contractor shall diligently pursue the work to the physical completion date within the time specified in the contract. Voluntary shutdown or slowing of operations by the Contractor shall not relieve the Contractor of the responsibility to complete the work within the time(s) specified in the contract.

When shown in the Plans, the first order of work shall be the installation of high visibility fencing to delineate all areas for protection or restoration, as described in the Contract. Installation of high visibility fencing adjacent to the roadway shall occur after the placement of all necessary signs and traffic control devices in accordance with 1-10.1(2). Upon construction of the fencing, the Contractor shall request the Engineer to inspect the fence. No other work shall be performed on the site until the Contracting Agency has accepted the installation of high visibility fencing, as described in the Contract.

**(December 1, 2021 CFW GSP)**

Section 1-08.4 is supplemented with the following.

The Contractor shall provide adequate equipment and forces to carry out the construction schedule to completion of the contract by the date specified.

**1-08.5 Time for Completion**

**(January 19, 2022 APWA GSP, OPTION A)**

Revise the third and fourth paragraphs to read:

Contract time shall begin on the first working day following the Notice to Proceed Date.

Each working day shall be charged to the contract as it occurs, until the contract work is physically complete. If substantial completion has been granted and all the authorized working days have been used, charging of working days will cease. Each week the Engineer will provide the Contractor a statement that shows the number of working days: (1) charged to the contract the week before; (2) specified for the physical completion of the contract; and (3) remaining for the physical completion of the contract. The statement will also show the nonworking days and any partial or whole day the Engineer declares as unworkable. The statement will be identified as a Written Determination by the Engineer. If the Contractor does not agree with the Written Determination of working days, the Contractor shall pursue the protest procedures in accordance with Section 1-04.5. By failing to follow the procedures of Section 1-04.5, the Contractor shall be deemed as having accepted the statement as correct. If the Contractor is approved to work 10 hours a day and 4 days a week (a 4-10 schedule) and the fifth day of the week in which a 4-10 shift is worked would ordinarily be charged as a working day then the fifth day of that week will be charged as a working day whether or not the Contractor works on that day.

Revise the sixth paragraph to read:

The Engineer will give the Contractor written notice of the completion date of the contract after all the Contractor's obligations under the contract have been performed by the Contractor. The following events must occur before the Completion Date can be established:

1. The physical work on the project must be complete; and
2. The Contractor must furnish all documentation required by the contract and required by law, to allow the Contracting Agency to process final acceptance of the



contract. The following documents must be received by the Project Engineer prior to establishing a completion date:

- a. Certified Payrolls (per Section 1-07.9(5)).
- b. Material Acceptance Certification Documents
- c. Monthly Reports of Amounts Credited as DBE Participation, as required by the Contract Provisions.
- d. Final Contract Voucher Certification
- e. Copies of the approved "Affidavit of Prevailing Wages Paid" for the Contractor and all Subcontractors
- f. A copy of the Notice of Termination sent to the Washington State Department of Ecology (Ecology); the elapse of 30 calendar days from the date of receipt of the Notice of Termination by Ecology; and no rejection of the Notice of Termination by Ecology. This requirement will not apply if the Construction Stormwater General Permit is transferred back to the Contracting Agency in accordance with Section 8-01.3(16).
- g. Property owner releases per Section 1-07.24

***(March 13, 1995 WSDOT GSP, OPTION 7)***

Section 1-08.5 is supplemented with the following:

This project shall be physically complete within 30 working days.

**1-08.6 Suspension of Work**

***(January 2, 2018 WSDOT GSP, OPTION 2)***

Section 1-08.6 is supplemented with the following:

Contract time may be suspended for procurement of critical materials (Procurement Suspension). In order to receive a Procurement Suspension, the Contractor shall within 21 calendar days after execution by the Contracting Agency, place purchase orders for all materials deemed critical by the Contracting Agency for physical completion of the contract. The Contractor shall provide copies of purchase orders for the critical materials. Such purchase orders shall disclose the purchase order date and estimated delivery dates for such critical material.

The Contractor shall show procurement of the materials listed below as activities in the Progress Schedule. If the approved Progress Schedule indicates the materials procurement are critical activities, and if the Contractor has provided documentation that purchase orders are placed for the critical materials within the prescribed 21 calendar days, then contract time shall be suspended upon physical completion of all critical work except that work dependent upon the listed critical materials:

NONE

Charging of contract time will resume upon delivery of the critical materials to the Contractor or 120 calendar days after execution by the Contracting Agency, whichever occurs first.

**1-08.9 Liquidated Damages**

***(March 3, 2021 APWA GSP, OPTION A)***

Replace Section 1-08.9 with the following:

Time is of the essence of the Contract. Delays inconvenience the traveling public, obstruct traffic, interfere with and delay commerce, and increase risk to Highway users. Delays also cost tax payers undue sums of money, adding time needed for administration, engineering, inspection, and supervision.

Accordingly, the Contractor agrees:

1. To pay liquidated damages in the amount of \$800.00 for each working day beyond the number of working days established for Physical Completion, and
2. To authorize the Engineer to deduct these liquidated damages from any money due or coming due to the Contractor.

When the Contract Work has progressed to Substantial Completion as defined in the Contract, the Engineer may determine the Contract Work is Substantially Complete. The Engineer will notify the Contractor in writing of the Substantial Completion Date. For overruns in Contract time occurring after the date so established, liquidated damages identified above will not apply. For overruns in Contract time occurring after the Substantial Completion Date, liquidated damages shall be assessed on the basis of direct engineering and related costs assignable to the project until the actual Physical Completion Date of all the Contract Work. The Contractor shall complete the remaining Work as promptly as possible. Upon request by the Project Engineer, the Contractor shall furnish a written schedule for completing the physical Work on the Contract.

Liquidated damages will not be assessed for any days for which an extension of time is granted. No deduction or payment of liquidated damages will, in any degree, release the Contractor from further obligations and liabilities to complete the entire Contract.

## **1-09 MEASUREMENT AND PAYMENT**

### **1-09.6 Force Account**

***(October 10, 2008 APWA GSP)***

Supplement this section with the following:

The Contracting Agency has estimated and included in the Proposal, dollar amounts for all items to be paid per force account, only to provide a common proposal for Bidders. All such dollar amounts are to become a part of Contractor's total bid. However, the Contracting Agency does not warrant expressly or by implication, that the actual amount of work will correspond with those estimates. Payment will be made on the basis of the amount of work actually authorized by Engineer.

### **1-09.7 Mobilization**

***(April 12, 2018 CFW GSP)***

Supplement Section 1-09.7 with the following:

Obtaining a site for the Contractor's mobilization, field office(s), storage of materials, access and personnel parking spaces, and other general operations shall be the responsibility of the Contractor. The Contractor will be responsible for maintaining these spaces in a safe and orderly condition throughout the duration of the project. The Contractor shall provide the City with a copy of agreement(s) with property owner. All costs associated with securing sites shall be included in the other bid items on the project and no other compensation will be made.

## **1-09.9 Payments**

**(January 19, 2022 APWA GSP)**

Section 1-09.9 is revised to read:

The basis of payment will be the actual quantities of Work performed according to the Contract and as specified for payment.

The Contractor shall submit a breakdown of the cost of lump sum bid items at the Preconstruction Conference, to enable the Project Engineer to determine the Work performed on a monthly basis. A breakdown is not required for lump sum items that include a basis for incremental payments as part of the respective Specification. Absent a lump sum breakdown, the Project Engineer will make a determination based on information available. The Project Engineer's determination of the cost of work shall be final.

Progress payments for completed work and material on hand will be based upon progress estimates prepared by the Engineer. A progress estimate cutoff date will be established at the preconstruction conference.

The initial progress estimate will be made not later than 30 days after the Contractor commences the work, and successive progress estimates will be made every month thereafter until the Completion Date. Progress estimates made during progress of the work are tentative, and made only for the purpose of determining progress payments. The progress estimates are subject to change at any time prior to the calculation of the final payment.

The value of the progress estimate will be the sum of the following:

1. Unit Price Items in the Bid Form — the approximate quantity of acceptable units of work completed multiplied by the unit price.
2. Lump Sum Items in the Bid Form — based on the approved Contractor's lump sum breakdown for that item, or absent such a breakdown, based on the Engineer's determination.
3. Materials on Hand — 100 percent of invoiced cost of material delivered to Job site or other storage area approved by the Engineer.
4. Change Orders — entitlement for approved extra cost or completed extra work as determined by the Engineer.

Progress payments will be made in accordance with the progress estimate less:

1. Retainage per Section 1-09.9(1), on non FHWA-funded projects;
2. The amount of progress payments previously made; and
3. Funds withheld by the Contracting Agency for disbursement in accordance with the Contract Documents.

Progress payments for work performed shall not be evidence of acceptable performance or an admission by the Contracting Agency that any work has been satisfactorily completed. The determination of payments under the contract will be final in accordance with Section 1-05.1.

Failure to perform any of the obligations under the Contract by the Contractor may be decreed by the Contracting Agency to be adequate reason for withholding any payments until compliance is achieved.

Upon completion of all Work and after final inspection (Section 1-05.11), the amount due the Contractor under the Contract will be paid based upon the final estimate made by the Engineer and presentation of a Final Contract Voucher Certification to be signed by the Contractor. The Contractor's signature on such voucher shall be deemed a release of all claims of the Contractor unless a Certified Claim is filed in accordance with the requirements of Section 1-09.11 and is expressly excepted from the Contractor's certification on the Final Contract Voucher Certification. The date the Contracting Agency signs the Final Contract Voucher Certification constitutes the final acceptance date (Section 1-05.12).

If the Contractor fails, refuses, or is unable to sign and return the Final Contract Voucher Certification or any other documentation required for completion and final acceptance of the Contract, the Contracting Agency reserves the right to establish a Completion Date (for the purpose of meeting the requirements of RCW 60.28) and unilaterally accept the Contract. Unilateral final acceptance will occur only after the Contractor has been provided the opportunity, by written request from the Engineer, to voluntarily submit such documents. If voluntary compliance is not achieved, formal notification of the impending establishment of a Completion Date and unilateral final acceptance will be provided by email with delivery confirmation from the Contracting Agency to the Contractor, which will provide 30 calendar days for the Contractor to submit the necessary documents. The 30 calendar day period will begin on the date the email with delivery confirmation is received by the Contractor. The date the Contracting Agency unilaterally signs the Final Contract Voucher Certification shall constitute the Completion Date and the final acceptance date (Section 1-05.12). The reservation by the Contracting Agency to unilaterally accept the Contract will apply to Contracts that are Physically Completed in accordance with Section 1-08.5, or for Contracts that are terminated in accordance with Section 1-08.10. Unilateral final acceptance of the Contract by the Contracting Agency does not in any way relieve the Contractor of their responsibility to comply with all Federal, State, tribal, or local laws, ordinances, and regulations that affect the Work under the Contract.

Payment to the Contractor of partial estimates, final estimates, and retained percentages shall be subject to controlling laws.

### **1-09.13 Claim Resolution**

#### **1-09.13(1) General**

***(January 19, 2022 APWA GSP)***

Revise this Section to Read

Prior to seeking claims resolution through arbitration or litigation, the Contractor shall proceed in accordance with Section 1-04.5 and 1-09.11. The provisions of Sections 1-04.5 and 1-09.11 must be complied with in full as a condition precedent to the Contractor's right to seek claim resolution through binding arbitration or litigation.

Any claims or causes of action which the Contractor has against the Contracting Agency arising from the Contract shall be resolved, as prescribed herein, through binding arbitration or litigation.

The Contractor and the Contracting Agency mutually agree that those claims or causes of action which total \$1,000,000 or less, which are not resolved by mediation, shall be resolved through litigation unless the parties mutually agree in writing to resolve the claim through binding arbitration.

The Contractor and the Contracting Agency mutually agree that those claims or causes of action in excess of \$1,000,000, which are not resolved by mediation, shall be resolved through litigation unless the parties mutually agree in writing to resolve the claim through binding arbitration.

**1-09.13(3)A Arbitration General**  
***(January 19, 2022 APWA GSP)***

Revise the third paragraph to read:

The Contracting Agency and the Contractor mutually agree to be bound by the decision of the arbitrator, and judgment upon the award rendered by the arbitrator may be entered in the Superior Court of the county in which the Contracting Agency's headquarters is located, provided that where claims subject to arbitration are asserted against a county, RCW 36.01.050 shall control venue and jurisdiction of the Superior Court. The decision of the arbitrator and the specific basis for the decision shall be in writing. The arbitrator shall use the Contract as a basis for decisions.

**1-09.13(4) Venue for Litigation**  
***(January 19, 2022 APWA GSP)***

Revise this section to read:

Litigation shall be brought in the Superior Court of the county in which the Contracting Agency's headquarters is located, provided that where claims are asserted against a county, RCW 36.01.050 shall control venue and jurisdiction of the Superior Court. It is mutually agreed by the parties that when litigation occurs, the Contractor shall permit the Contracting Agency to have timely access to any records deemed necessary by the Contracting Agency to assist in evaluating the claims or action.

**END OF DIVISION 1**

## **DIVISION 2 EARTHWORK**

### **2-02 REMOVAL OF STRUCTURES AND OBSTRUCTIONS**

#### **2-02.3 Construction Requirements**

***(October 4, 2021 WSDOT GSP, OPTION 5)***

Section 2-02.3 is supplemented with the following:

##### **Removal and Disposal of Asbestos Material**

In the event suspected Asbestos Containing Material (ACM) is encountered, the Contractor shall immediately notify the Engineer and the provisions of Section 1-04.7 shall apply. Prior to commencing asbestos related work, the Contractor shall obtain all permits from and provide notification to, the Washington State Department of Labor and Industries, the Washington State Department of Ecology, the local clean air agency, and other permitting and regulatory agencies with jurisdiction over the work involving asbestos as the laws, rules, and regulations require.

The ACM shall only be disturbed under the supervision of a Washington State Certified Asbestos Supervisor (CAS). The CAS shall be certified in accordance with WAC 295-65-012.

The CAS shall supervise the asbestos removal and ensure that the handling and removal of asbestos is accomplished by certified asbestos workers and in accordance with Washington State Department of Labor and Industries standards. The Contractor shall ensure that the removal and disposal of asbestos meets the requirements of EPA regulation 40 CFR Part 61, local health department regulations, and all other applicable regulations.

No asbestos is expected to be encountered. However, if the Contractor believes they have encountered asbestos, they shall immediately notify the Engineer in accordance with Section 1-04.7.

#### **2-02.3(3) Removal of Pavement, Sidewalks, Curbs, and Gutters**

***(December 22, 2022 CFW PROJECT SPECIFIC GSP)***

Section 2-02.3(3) is supplemented with the following:

Prior to removal of pavement, the Contractor shall make a full-depth sawcut to delineate the areas of pavement removal from those areas of pavement to remain. The Engineer shall approve the equipment and procedures used to make the full-depth sawcut. No wastewater from the sawcutting operation shall be released directly to any stream or storm sewer system.

Removal of pavement, sidewalks, curbs or gutters that is required to facilitate removal of the existing building foundation, removal of existing street lighting system, or removal of existing utility connections shall be considered incidental. No additional payment shall be made for sawcut, removal, haul or disposal of existing pavement, concrete, sidewalks, curbs or gutters.

#### **2-02.3(4) Removing Existing Illumination**

***(December 22, 2012 CFW PROJECT SPECIFIC GSP)***

Section 2-02.3(4) is a new section:

The existing illumination system is believed to be non-functioning due to lack of wiring and crushed conduit paths that prohibit the installation of new wiring. The removal of the existing illumination system as shown in the plans or indicated by the Engineer entails removal of the Luminaire poles from the existing foundation. Luminaire poles and the light fixtures themselves shall become property of the contractor. Existing foundations shall remain in place.

Existing wiring encountered, if any, shall be removed to the nearest junction box or as directed by the Engineer. The removed wiring and/or conduits shall be salvaged from the site and become property of the contractor.

**2-02.3(5) Adjust Existing Utility to Grade**  
***(April 12, 2018 CFW GSP)***

2-02.3(5) is a new section:

As shown in the Plans, existing utilities such as monuments, manholes, catch basin frames and grates, water valves, and meter boxes shall be adjusted to finished grade. The Contractor shall, prior to the beginning of any work, familiarize himself with the existing utility locations. The Contractor shall adjust City-owned utilities. Final adjustment shall be smooth and flush with finished grade. The Contractor shall mark the location of all utilities prior to paving the new surface. Unless otherwise provided for in the Special Provisions and Proposal, costs for adjusting utilities to grade, including coordinating the work with other utilities, shall be incidental to the various items of work and no additional compensation will be allowed.

Existing facilities shall be adjusted to the finished grade as shown in the Drawings and as further specified herein. Existing box, ring, grate, and cover shall be reset in a careful and workmanlike manner to conform to the new grade. Special care shall be exercised in all operations. Any damage occurring to the manholes, concrete inlets, monument cases, valve boxes, or water mains, due to the Contractor's operations, shall be repaired at the Contractor's own expense. Adjustments shall be made using bricks, concrete blocks, or cement, and the interior of the manhole adjustment shall be mortared smoothly. All covers and frames shall be thoroughly cleaned. The Contractor shall be responsible for referencing and keeping a record of such references of all manholes, catch basins, monument cases, meter boxes, and valve boxes encountered, and shall submit a copy of these references to the Engineer.

The manholes, catch basins, monument cases, meter boxes, and valve boxes shall be adjusted to grade in accordance with Section 1-05.3(1). Final restoration of finished grade surfaces shall be performed in the following manner:

1. Within a Gravel Surface: Provide a 6-inch-deep and 6-inch-wide concrete collar installed and restored with 3 inches of crushed surfacing top course.
2. Within a Grass Surface: Provide crushed surfacing top course backfill and 3 inches of Topsoil Type A, and seed.
3. Within an Asphalt Cement Concrete Paved Surface: See City standard detail for Utility Adjustment.

### **2-02.3(6) Existing Utilities to Remain**

***(April 12, 2018 CFW GSP)***

2-02.3(6) is a new section:

Utilities indicated in the Plans to remain shall be protected and supported in place in such a manner that they remain functional and undamaged. Utilities indicated to remain that are damaged as a result of Contractor's activity shall be repaired or replaced to the satisfaction of the Contracting Agency at no additional cost.

### **2-02.4 Vacant**

***(December 21, 2022 CFW PROJECT SPECIFIC GSP)***

Section 2-02.4 Vacant shall be deleted and replaced with the following:

#### **2-02.4 Measurement**

"Removing Existing Illumination" shall be measured as a lump sum all-inclusive price to complete the described work.

"Removal of Structure and Obstruction" shall be measured as a lump sum all-inclusive price to complete the described work.

### **2-02.5 Payment**

***(December 21, 2022 CFW PROJECT SPECIFIC GSP)***

Section 2-02.5 is supplemented with the following:

Payment will be made in accordance with Section 1-04.1 for the following bid items when included in the proposal:

"Removing Existing Illumination", lump sum, shall be full pay for all labor, tools, materials, equipment, permits, fees, demolition, haul and disposal necessary for the removal of the existing illumination system as shown in the plans or directed by the Engineer.

"Removal of Structure and Obstruction", lump sum, shall be full pay for all labor, tools, materials, equipment, permits, fees, demolition, sawcutting, compaction, haul and disposal necessary for the demolition and removal of the existing building and foundation from the project site. Also included is all labor, tools, materials, equipment, haul, spreading and compaction required for final restoration of the area disturbed by removal of the existing foundation and any areas disturbed for decommission of existing building utilities. Final restoration of the above described disturbed areas shall be CSTC, gravel borrow, or native backfill, if approved by the Engineer, placed in lifts of no more than 6 inches up to a level of 4 inches below the grade of the adjacent undisturbed area, and then topped with 4 inches of 5/8" crushed surfacing top course (CSTC).

## **2-03 ROADWAY EXCAVATION AND EMBANKMENT**

### **2-03.2 Pavement Removal**

***(April 12, 2018 CFW PROJECT SPECIFIC GSP)***

Section 2-03.2 is replaced with the following:

Where shown in the Plans or where designated by the Engineer, the Contractor shall remove asphalt, concrete, Portland cement concrete pavement, sidewalks and curbs.

Prior to removal, the Contractor shall make a full-depth sawcut to delineate the areas of pavement removal from those areas of pavement to remain. The Engineer shall approve the equipment and procedures used to make the full-depth sawcut. No wastewater from



the sawcutting operation shall be released directly to any stream or storm sewer system. Alternatively, the Contractor may elect grinding for pavement removal, where appropriate.

The removed pavement shall become the property of the Contractor and shall be removed from the project. Damage caused to portions of the pavement to remain, due to the Contractor's operation, shall be repaired by the Contractor at the Contractor's expense and to the satisfaction of the Engineer.

### **2-03.3 Construction Requirements**

#### **Section 2-03.3(10) Selected Material**

***(April 12, 2018 CFW GSP)***

Section 2-03.3(10) is supplemented with the following:

Selected Material when specified or required by the Engineer for use on the project shall meet the requirements of specified in Section 9-03.14(3) for Common Borrow.

#### **Section 2-03.3(14)G Backfilling**

***(April 12, 2018 CFW GSP)***

Section 2-03.3(14)G is supplemented with the following:

Remove all water and non-compatible materials from excavations prior to backfilling or attempting to compact embankment soil. Provide import Gravel Borrow as required to complete the work. Backfill all embankments in accordance with 2-03.3(14)C, Compacting Earth Embankments, Method C.

#### **Section 2-03.3(14)N Wet Weather Earthwork**

***(April 12, 2018 CFW GSP)***

Section 2-03.3(14)N is a new section:

Earthwork completed in wet weather or under wet conditions shall be accomplished in small sections to minimize exposure to wet weather. Each section shall be sufficiently small so that the removal of soil and placement of backfill can be accomplished on the same day. No soil shall be left un-compacted and exposed to water. Soil that is too wet for compaction shall be removed and replaced with Gravel Borrow material. Grading and earthwork should not be accomplished during periods of heavy continuous rainfall.

#### ***(April 12, 2018 CFW PROJECT SPECIFIC GSP)***

Section 2-03.4 is supplemented with the following:

If the Contractor performs extra excavation, it shall be considered for the Contractor's benefit and shall be included in the cost of other Bid Items.

#### ***(March 13, 1995 WSDOT GSP, OPTION 2)***

Section 2-03.5 is supplemented with the following:

All costs in connection with the preparation of waste sites and waste deposits shall be included in the Mobilization.

## **2-09 STRUCTURE EXCAVATION**

### **2-09.3 Construction Requirements**

#### **2-09.3(1) General Requirements**

***(March 17, 2020 CFW GSP)***

Section 2-09.3(1) is supplemented with the following:

All shoring, including sheeting and bracing, or equivalent trench stabilization and worker protection system required to perform and protect the excavation, and to safeguard the personnel who may enter the excavation, shall be furnished by the Contractor. If workers enter any trench or other excavation four feet (4') or more in depth that does not meet the open pit requirements as generally set forth in Section 2-09.3(3)B, it shall be shored.

The Contractor alone shall be responsible for worker safety, and the Contracting Agency assumes no responsibility therefore.

Upon completing the Work, the Contractor shall remove all shoring, unless otherwise shown on the Plans or directed by the Engineer.

The Contractor is advised that the Contracting Agency has not so delegated, and the Engineer does not purport to be, a trench excavation system safety expert, is not so engaged in that capacity under this Contract, and has neither the authority nor the responsibility to enforce construction safety laws, rules, regulations, or procedures, or to order the suspension of work for claimed violations of trench excavation safety.

The furnishing by the Contracting Agency of resident project representation and inspection shall not make the Contracting Agency responsible for the enforcement of such laws, rules, regulations, or procedures, nor shall such make the Contracting Agency responsible for construction means, methods, techniques, sequences, procedures, or for the Contractor's failure to properly perform the Work necessary for proper trench excavation.

**2-09.3(1)D Disposal of Excavated Material**  
***(March 17, 2020 CFW GSP)***

Replace the third paragraph with the following:

If the Contract includes Structure Excavation, Class A or B, including haul; Shoring or Extra Excavation, Class A or B; or Trench Safety System, the unit contract price shall include all costs for loading and hauling excavated materials to a permitted disposal site, or to and from a temporary stockpile. Any such stockpiled materials, either suitable or designated for incorporation into the project, shall be handled in accordance with Section 2-09.3(1)E.

**2-09.3(1)E Backfilling**  
***(April 12, 2018 CFW GSP)***

The first paragraph of Section 2-09.3(1) is replaced with the following:

The backfilling of openings dug for Structures or for Removal of Structures and Obstructions shall be a necessary part of and incidental to the excavation. Backfill material shall be Gravel Borrow unless the use of native or other material is approved by the engineer.

## **END OF DIVISION 2**

**DIVISION 3  
AGGREGATE PRODUCTION AND ACCEPTANCE**

**3-01 PRODUCTION FROM QUARRY AND PIT SITES**

**3-01.4 Contractor Furnished Material Sources**

**3-01.4(1) Acquisition and Development**

*(April 12, 2018 CFW GSP)*

Section 3-01.4(1) is supplemented with the following:

No source has been provided for any materials necessary for the construction of these improvements.

If the source of material provided by the Contractor necessitates hauling over roads other than City streets, the Contractor shall, at his own cost and expense, make all arrangements for the use of haul routes.

**END OF DIVISION 3**

## DIVISION 4 BASES

### 4-04 BALLAST AND CRUSHED SURFACING

#### 4-04.3 Construction Requirements

##### 4-04.3(3) Mixing

*(April 12, 2018 CFW GSP)*

Item 2 of Section 4-04.3(3), is replaced with the following:

2. **Road Mix Method** - The road mix method of mixing surfacing material will not be allowed.

##### 4-04.3(4) Placing and Spreading

*(April 12, 2018 CFW GSP)*

Item 2 of Section 4-04(4), is replaced with the following:

2. **Road Mix Method** - The road mix method of mixing surfacing material will not be allowed.

**END OF DIVISION 4**

**DIVISION 7  
DRAINAGE STRUCTURES, STORM SEWERS,  
SANITARY SEWERS, WATER MAINS, AND CONDUITS**

**7-08 GENERAL PIPE INSTALLATION REQUIREMENTS**

**7-08.3 Construction Requirements**

**7-08.3(4) Plugging Existing Pipe**

***(December 21, 2022 CFW PROJECT SPECIFIC GSP)***

Section 7-08.3(4) is replaced with the following:

Where shown in the Plans or where designated by the Engineer, existing pipes shall be plugged for a distance of 2 diameters with commercial concrete. Care shall be used in placing the concrete in the pipe to see that the opening of the pipe is completely filled and thoroughly plugged.

**7-08.4 Measurement**

***(December 21, 2022 CFW PROJECT SPECIFIC GSP)***

Plugging pipes will be measured per each, for each plug installed. Plugs will be subject to final acceptance by the respective utility having ownership of the previously receiving conveyance system.

**7-08.5 Payment**

***(December 21, 2022 CFW PROJECT SPECIFIC GSP)***

Payment will be made for the following bid items when included in the proposal:

“Plugging Existing Pipe”, per each.

The unit contract price per each for Plugging Existing Pipe shall be full pay for furnishing all labor, tools, equipment, and materials necessary to install a plug at the location indicated on the Plans. The unit contract price per each for Plugging Existing Pipe shall also include sawcut, excavation, imported backfill, compaction, and adjustment to finished grade. No additional payment will be made when the work is completed from within existing manholes.

**7-15 SERVICE CONNECTIONS**

**7-15.3 Construction Requirements**

***(December 21, 2022 CFW PROJECT SPECIFIC GSP)***

Section 7-15.3 is replaced with the following:

Where shown in the plans or where designated by the Engineer, existing service pipes shall be cut using a tool or tools specifically designed to leave a smooth, even and square end on the piping material to be cut. Cut ends shall be reamed to the full inside diameter of the pipe. Pipe ends to be connected or capped using fittings which seal to the outside surface of the pipe shall be cleaned to a sound, smooth finish before the fittings are installed. The existing meter box(es) shall be adjusted to finished grade after the surface has been acceptably restored.

The depth of trenching for service connection piping to remain shall provide a minimum of 3 feet of cover over the top of the pipe. Particular care shall be exercised to ensure that the main is not damaged by the work undertaken to decommission the existing water

service line and/or building demolition work. All fittings, appurtenances, and other miscellaneous materials on the sections of existing pipes to be removed shall become the property of the Contractor.

**7-15.4 Measurement**

***(December 21, 2022 CFW PROJECT SPECIFIC GSP)***

Removal of Service Connection will be measured per each, for each service line decommissioned regardless of the size. Caps or plugs will be subject to final acceptance by the respective utility having ownership of the previously connected system.

**7-15.5 Payment**

***(December 21, 2022 CFW PROJECT SPECIFIC GSP)***

Payment will be made for the following bid items when included in the proposal:

“Remove Service Connection”, per each.

The unit contract price per each for Remove Service Connection shall be full pay for furnishing all labor, tools, equipment, and materials necessary to install a plug or cut and cap existing service lines at the location shown in the Plans or where designated by the Engineer. The unit contract price per each for Remove Service Connection shall also include sawcut, excavation, imported backfill, compaction, protection of existing meter boxes, protection of existing valves, and adjustment to finished grade of existing meter boxes, valve boxes or other related appurtenances.

**END OF DIVISION 7**

## **DIVISION 8 MISCELLANEOUS CONSTRUCTION**

### **8-01 EROSION CONTROL AND WATER POLLUTION CONTROL**

#### **8-01.3 Construction Requirements**

##### **8.01.3(1) General**

***(April 12, 2018 CFW GSP)***

The first paragraph of 8-01.3(1) is deleted and replaced with the following:

The Contractor shall install a high visibility fence along the right-of-way lines shown in the Plans or as instructed by the Engineer.

##### **8-01.3(1)A Submittals**

***(April 12, 2018 CFW GSP)***

Section 8-01.3(1)A is revised to read:

A Stormwater Pollution Prevention Plan (SWPPP) shall be prepared by the Contractor and submitted for approval to the Engineer. The plan shall consist of the Contractor's complete strategy to meet the requirements of the Department of Ecology's NPDES and State Waste Discharge General Permit for Stormwater Discharges Associated With Construction Activity (General Permit). The SWPPP shall include and modify as necessary the Site Preparation and Erosion Control Plan drawings provided as part of the Contract Plans. The Contractor shall prepare review and modify the SWPPP as necessary to be consistent with the actual work schedule, sequencing, and construction methods that will be used on the project. The Contractor's SWPPP shall meet the requirements of the general permit. The Contractor's modifications to the SWPPP shall also incorporate the content and requirements for the Spill Prevention, Control and Countermeasures (SPCC) Plan in accordance with Section 1-07.15(1).

The SWPPP shall document all the erosion and sediment control Best Management Practices (BMPs) proposed, whether permanent or temporary. The plan shall document installation procedures, materials, scheduling, and maintenance procedures for each erosion and sediment control BMP. The Contractor shall submit the SWPPP for the Engineer's approval before any work begins. The Contractor shall allow at least five working days for the Engineer's review of the initial SWPPP or any revisions to the modified SWPPP. Failure to approve all or part of any such plan shall not make the Contracting Agency liable to the Contractor for any work delays. The Contractor may not begin work without an approved Contractor's SWPPP.

The Contractor shall complete and modify the SWPPP to meet the Contractor's schedule and method of construction. All TESC Plans shall meet the requirements of the current edition of the WSDOT Temporary Erosion and Sediment Control Manual M 3109 and be adapted as needed throughout construction based on site inspections and discharge samples to maintain compliance with the CSWGP. The Contractor shall develop a schedule for implementation of the SWPPP work and incorporate it into the Contractor's progress schedule.

In addition, the SWPPP shall outline the procedures to be used to prevent high pH stormwater or dewatering water from entering surface waters. The plan shall

include how the pH of the water will be maintained between pH 6.5 and pH 8.5 prior to being discharged from the project or entering surface waters. Prior to beginning any concrete or grinding work, the Contractor shall submit the plan, for the Engineer's review and approval.

As a minimum, the SWPPP shall include all the SWPPP requirements identified in the General Permit, including:

Narrative discussing and justifying erosion control decisions (12 elements)

Drawings illustrating BMPs types and locations

Engineering calculations for ponds and vaults used for erosion control

A schedule for phased installation and removal of the proposed BMPs, including:

- A. BMPs that will be installed at the beginning of project startup.
- B. BMPs that will be installed at the beginning of each construction season.
- C. BMPs that will be installed at the end of each construction season.
- D. BMPs that will be removed at the end of each construction season.
- E. BMPs that will be removed upon completion of the project.

An Ecology template is available to the Contractor for producing the SWPPP, using project- specific information added by the Contractor. The template and instructions are available at:

<http://www.ecy.wa.gov/programs/wq/stormwater/construction/>

### **Turbidity and pH Exceedances**

Following any exceedances of the turbidity or pH benchmarks, the Contractor shall provide the following at no additional cost to the Contracting agency:

1. The necessary SWPPP revisions and on-site measures/revisions including additional source control, BMP maintenance, and/or additional stormwater treatment BMPs that are necessary to prevent continued exceedance of turbidity and/or pH benchmarks.
2. The regulatory notification to the Dept. of Ecology and to the Engineer of any monitoring results requiring regulatory notification.
3. The additional daily sampling and reporting measures described in the General Permit to verify when project site runoff is in compliance.

### **8-01.3(1)B Erosion and Sediment Control (ESC) Lead** **(October 3, 2022 WSDOT GSP, OPTION 1)**

Item number 3 and 4 in the second paragraph of Section 8-01.3(1)B are revised to read:

3. Submit to the Engineer no later than the end of the next working day following the inspection a TESC Inspection Report that includes:
  - a. When, where, and how BMPs were installed, maintained, modified, and removed.



- b. Observations of BMP effectiveness and proper placement.
- c. Recommendations for improving future BMP performance with upgraded or replacement BMPs when inspections reveal TESC BMP deficiencies.
- d. Identify for each discharge point location whether there is compliance with state water quality standards in WAC 173-201A for turbidity and pH.

## **8-20 ILLUMINATION, TRAFFIC SIGNAL SYSTEMS, INTELLIGENT TRANSPORTATION SYSTEMS, AND ELECTRICAL**

### **8-20.1 Description**

#### **8-20.1(1) Regulations and Code**

***(March 13, 2012 CFW GSP)***

Section 8-20.1(1) is supplemented with the following:

Where applicable, materials shall conform to the latest requirements of Puget Sound Energy and the Washington State Department of Labor and Industries.

#### **8-20.1(2) Industry Codes and Standards**

***(March 13, 2012 CFW GSP)***

The following is added at the end of the first paragraph of this section:

National Electrical Safety Code (NESC) Committee, IEEE Post Office Box 1331445 Hoes Lane, Piscataway, NJ 08855-1331.

#### **8-20.1(3) Permitting and Inspections**

***(April 12, 2018 CFW GSP)***

Section 8-20.1(3) is supplemented with the following:

The Contractor shall be responsible for obtaining all required electrical permits, including all required City electrical permits. All costs to obtain and comply with electrical permits shall be included in the applicable bid items for the work involved.

### **8-20.3 Construction Requirements**

#### **8-20.3(1) General**

***(January 26, 2012 CFW GSP)***

Section 8-20.3(1) is supplemented with the following:

##### **Contractor Owned Removals**

All removals associated with an electrical system, which are not designated to remain the property of the Contracting Agency, shall become the property of the Contractor and shall be removed from the project.

The Contractor shall:

Remove all wires for discontinued circuits from the conduit system or as directed by the Engineer.

Remove elbow sections of abandoned conduit entering junction boxes or as directed by the Engineer.

Abandoned conduit encountered during excavation shall be removed to the nearest outlets or as directed by the Engineer.

Remove foundations entirely, unless the Plans state otherwise.

Backfill voids created by removal of foundations and junction boxes. Backfilling and compaction shall be performed in accordance with Section 2-09.3(1)E.

**8-20.3(2) Excavating and Backfilling**  
***(December 16, 2022 CFW GSP)***

Section 8-20.3(2) is supplemented with the following:

The Contractor shall supply all trenching necessary for the complete and proper installation of the traffic signal system, interconnect conduit and wiring, and illumination system.

Trenching shall conform to the following:

1. In paved areas, edges of the trench shall be sawcut the full depth of the pavement and sawcuts shall be parallel. All trenches for placement of conduit shall be straight and as narrow in width as practical to provide a minimum of pavement disturbance. The existing pavement shall be removed in an approved manner. The trench bottom shall be graded to provide a uniform grade.

2. Bedding and backfill materials for electrical trenches shall be as follows:

Electrical conduit trench depth shall be a minimum of 24 inches cover over conduits.

Bedding material for trenches 18 inches or less in width shall be crushed surfacing top course. Bedding material for trenches greater than 18 inches or for joint utility trenches shall be pit run sand. Bedding material shall be placed two inches below the conduit(s) and shall extend to two inches above the conduit(s).

Backfill material for trenches located within the roadway limits (back of curb to back of curb), including perpendicular crossings of roadways and underneath driveways shall be controlled density fill (CDF), vibrated in place.

Backfill material for trenches located outside of roadway and driveway limits shall be Bank Run Gravel for Trench Backfill conforming to WSDOT 9-03.19, unless the engineer determines that native material is suitable.

3. Backfill shall be carefully placed so that the backfilling operation will not disturb the conduit in any way. The backfill shall be thoroughly mechanically tamped in eight-inch (8") layers with each layer compacted to ninety-five percent (95%) of maximum density in traveled ways, and ninety percent (90%) of maximum density elsewhere at optimum soil moisture content.

Excavation for foundations shall be completed by vector excavation. This excavation shall be incidental to the signal or illumination bid items.

**(April 12, 2018 CFW PROJECT SPECIFIC GSP)**

Section 8-20.3(2) is supplemented with the following:

Underground utilities of record are shown on the construction Plans insofar as information is available. These, however, are shown for convenience only and the City assumes no responsibility for improper locations or failure to show utility locations on the construction Plans.

The location of existing underground utilities, when shown on the Plans, is approximate only, and the Contractor shall be responsible for determining their exact location. The Contractor shall check with the utility companies concerning any possible conflict prior to commencing excavation in any area, as not all utilities may be shown on the Plans.

The Contractor shall be entirely responsible for coordination with the utility companies and arranging for the movement or adjustment, either temporary or permanent, of their facilities within the project limits.

The Contractor shall not attempt to adjust the location of an existing utility unless specifically agreed to by the utility owner.

**END OF DIVISION 8**

# DIVISION 9 MATERIALS

## **9-03 AGGREGATES**

### **9-03.12 Gravel Backfill**

#### **9-03.12(6) Pit Run Sand** ***(April 12, 2018 CFW GSP)***

Section 9-03.12(6) is a new section:

<u>Sieve Size</u>	<u>Percent Passing</u>
3/8" square	100
U.S. No. 4	90
Sand Equivalent	30 minimum

#### **9-03.14(3) Common Borrow** ***(April 12, 2018 CFW GSP)***

Section 9-03.14(3) is modified with the following requirements:

Material from on-site excavations meeting the requirements for Common Borrow shall be used to the extent practicable. Material for common borrow shall consist of granular soil and/or aggregate which is free of trash, wood, debris, and other deleterious material.

Common Borrow material shall be at the proper moisture content for compaction. This material is generally moisture sensitive. The natural moisture content shall range from not more than 1 percent wet of optimum to not more than 3 percent dry of optimum as determined in accordance with Section 2-03.3(14)D. The material shall not pump or yield under the weight of compaction equipment and construction traffic. The Contractor is responsible for protecting the material from excess moisture wherever/whenever possible. To the extent practicable, this material should be handled only during non-rainy periods and should be removed, hauled, placed, and compacted into final embankments without intermediate handling or stockpiling. Surfaces should be graded and sloped to drain and should not be left uncompacted.

Common Borrow shall meet the following gradation limits:

<b>Sieve Size</b>	<b>Percent Passing (by weight)</b>
6" square <sup>1</sup>	100
4" square	90 – 100
2" square	75 - 100
U.S. No. 4	50 - 80
U.S. No. 40	50 max.
U.S. No 200	25 max.

<sup>1</sup> For geosynthetic reinforced walls or slopes, 100percent passing 1¼-inch square sieve and 90 to 100 percent passing the 1-inch square sieve.

Common Borrow shall contain sufficient fines for compaction and to bind the compacted soil mass together to form a stable surface when heavy construction equipment is operated on its surface.

**Standard Plans**

**(September 30, 2022 WSDOT)**

The State of Washington Standard Plans for Road, Bridge and Municipal Construction M21-01, effective September 30, 2022 is made a part of this contract.

The Standard Plans are revised as follows:

A-10.30

RISER RING detail (Including SECTION view and RISER RING DIMENSIONS table): The RISER RING detail is deleted from the plan.

INSTALLATION detail, SECTION A: The "1/4" callout is revised to read "+/- 1/4" (SEE CONTRACT ~ Note: The + 1/4" installation is shown in the Section A view)"

B-90.40

Valve Detail – DELETED

C-8

DELETED

C-8A

DELETED

C-23.60

DELETED

D-2.04

DELETED

D-2.06

DELETED

D-2.08

DELETED

D-2.32

DELETED

D-2.34

DELETED

D-2.60

DELETED

D-2.62

DELETED

D-2.64

DELETED

D-2.66

DELETED

D-2.68

DELETED

D-2.80

DELETED

D-2.88

DELETED

D-3.15

DELETED

D-3.16

DELETED

D-3.17

DELETED

D-3.10

Sheet 1, Typical Section, callout – “FOR WALLS WITH SINGLE SLOPE TRAFFIC BARRIER. USE THE DETAILS ABOVE THE MATCH LINE ON STANDARD PLAN D-3.15” is revised to read; “FOR WALLS WITH SINGLE SLOPE TRAFFIC BARRIER, SEE CONTRACT PLANS”

Sheet 1, Typical Section, callout – “FOR WALLS WITH F-SHAPE TRAFFIC BARRIER. USE THE DETAILS ABOVE THE MATCH LINE ON STANDARD PLAN D-3.16” is revised to read; “FOR THE WALLS WITH F-SHAPE TRAFFIC BARRIER, SEE CONTRACT PLANS”

D-3.11

Sheet 1, Typical Section, callout – “B” BRIDGE APPROACH SLAB (SEE BRIDGE PLANS) OR PERMANENT GEOSYNTHETIC WALL BARRIER ~ SEE STANDARD PLANS D-3.15 OR D-3.16” is revised to read; “B” BARRIER APPROACH SLAB OR MOMENT SLAB (SEE CONTRACT PLANS)

Sheet 1, Typical Section, callout – “TYPICAL BARRIER ON BRIDGE APPROACH SLAB (SEE BRIDGE PLANS) OR PERMANENT GEOSYNTHETIC WALL BARRIER ~ SEE STANDARD PLANS D-3.15 OR D-3.16” is revised to read; “TYPICAL BARRIER ON BRIDGE APPROACH SLAP OR MOMENT SLAB (SEE CONTRACT PLANS)

D-10.10

Wall Type 1 may be used if no traffic barrier is attached on top of the wall. Walls with traffic barriers attached on top of the wall are considered non-standard and shall be designed in accordance with the current WSDOT Bridge Design Manual (BDM) and the revisions stated in the 11/3/15 Bridge Design memorandum.

D-10.15

Wall Type 2 may be used if no traffic barrier is attached on top of the wall. Walls with traffic barriers attached on top of the wall are considered non-standard and shall be designed in accordance with the current WSDOT BDM and the revisions stated in the 11/3/15 Bridge Design memorandum.

D-10.30

Wall Type 5 may be used in all cases.

D-10.35

Wall Type 6 may be used in all cases.

D-10.40

Wall Type 7 may be used if no traffic barrier is attached on top of the wall. Walls with traffic barriers attached on top of the wall are considered non-standard and shall be designed in accordance with the current WSDOT BDM and the revisions stated in the 11/3/15 Bridge Design memorandum.

D-10.45

Wall Type 8 may be used if no traffic barrier is attached on top of the wall. Walls with traffic barriers attached on top of the wall are considered non-standard and shall be designed in accordance with the current WSDOT BDM and the revisions stated in the revisions stated in the 11/3/15 Bridge Design memorandum.

D-15.10

STD Plans D-15 series "Traffic Barrier Details for Reinforced Concrete Retaining Walls" are withdrawn. Special designs in accordance with the current WSDOT BDM are required in place of these STD Plans.

D-15.20

STD Plans D-15 series "Traffic Barrier Details for Reinforced Concrete Retaining Walls" are withdrawn. Special designs in accordance with the current WSDOT BDM are required in place of these STD Plans.

D-15.30

STD Plans D-15 series "Traffic Barrier Details for Reinforced Concrete Retaining Walls" are withdrawn. Special designs in accordance with the current WSDOT BDM are required in place of these STD Plans.

F-10.18

Note 2, "Region Traffic engineer approval is needed to install a truck apron lower than 3".  
- DELETED

J-10.10

Sheet 4 of 6, "Foundation Size Reference Table", PAD WIDTH column, Type 33xD=6' – 3" is revised to read: 7' – 3". Type 342LX / NEMA P44=5' – 10" is revised to read: 6' – 10"  
Sheet 5 of 6, Plan View, "FOR EXAMPLE PAD SHOWN HERE:", "first bullet" item, "-SPACE BETWEEN TYPE B MOD. CABINET AND 33x CABINET IS 6" (IN)" IS REVISED TO READ: "SPACE BETWEEN TYPE B MOD. CABINET (BACK OF ALL CHANNEL STEEL) AND 33x CABINET IS 6" (IN) (CHANNEL STEEL ADDS ABOUT 5" (IN))"

J-10.16

Key Note 1, Standard Plan J-10.30 revised to Standard Plan J-10.14

J-10.17

Key Note 1, Standard Plan J-10.30 revised to Standard Plan J-10.14

J-10.18

Key Note 1, Standard Plan J-10.30 revised to Standard Plan J-10.14

J-20.10

Elevation View, horizontal dimension to edge of sidewalk 1" (IN) OR LESS DESIRABLE ~ 18" (IN) MAXIMUM is revised to read: "10" (IN) MAXIMUM"

J-20.26

Add Note 1, "1. One accessible pedestrian pushbutton station per pedestrian pushbutton post."

J-20.16

View A, callout, was – LOCK NIPPLE, is revised to read; CHASE NIPPLE

J-21.10

Sheet 1, Elevation View, Round Concrete Foundation Detail, callout – "ANCHOR BOLTS ~ 3/4" (IN) x 30" (IN) FULL THREAD ~ THREE REQ'D. PER ASSEMBLY" IS REVISED TO READ: "ANCHOR BOLTS ~ 3/4" (IN) x 30" (IN) FULL THREAD ~ FOUR REQ'D. PER ASSEMBLY"

Sheet 1 of 2, Elevation view (Round), add dimension depicting the distance from the top of the foundation to find 2 #4 reinforcing bar shown, to read; 3" CLR.. Delete "(TYP.)" from the 2 1/2" CLR. dimension, depicting the distance from the bottom of the foundation to find 2 # 4 reinf. Bar.

Sheet 1 of 2, Elevation view (Square), add dimension depicting the distance from the top of the foundation to find 1 #4 reinforcing bar shown, to read; 3" CLR. Delete "(TYP.)" from the 2 1/2" CLR. dimension, depicting the distance from the bottom of the foundation to find 1 # 4 reinf. Bar.

Sheet 2 of 2, Elevation view (Round), add dimension depicting the distance from the top of the foundation to find 2 #4 reinforcing bar shown, to read; 3" CLR. Delete "(TYP.)" from the 2 1/2" CLR. dimension, depicting the distance from the bottom of the foundation to find 2 # 4 reinf. Bar.

Sheet 2 of 2, Elevation view (Square), add dimension depicting the distance from the top of the foundation to find 1 #4 reinforcing bar shown, to read; 3" CLR. Delete "(TYP.)" from the 2 1/2" CLR. dimension, depicting the distance from the bottom of the foundation to find 1 # 4 reinf. Bar.

Detail F, callout, "Heavy Hex Clamping Bolt (TYP.) ~ 3/4" (IN) Diam. Torque Clamping Bolts (see Note 3)" is revised to read; "Heavy Hex Clamping Bolt (TYP.) ~ 3/4" (IN) Diam. Torque Clamping Bolts (see Note 1)"

Detail F, callout, "3/4" (IN) x 2' – 6" Anchor Bolt (TYP.) ~ Four Required (See Note 4)" is revised to read; "3/4" (IN) x 2' – 6" Anchor Bolt (TYP.) ~ Three Required (See Note 2)"

J-21.15

Partial View, callout, was – LOCK NIPPLE ~ 1 1/2" DIAM., is revised to read; CHASE NIPPLE ~ 1 1/2" (IN) DIAM.

J-21.16

Detail A, callout, was – LOCKNIPPLE, is revised to read; CHASE NIPPLE

J-22.15



Ramp Meter Signal Standard, elevation, dimension 4' - 6" is revised to read; 6'-0" (2x) Detail A, callout, was – LOCK NIPPLE ~ 1 ½" DIAM. is revised to read; CHASE NIPPLE ~ 1 ½" (IN) DIAM.

J-40.10

Sheet 2 of 2, Detail F, callout, "12 – 13 x 1 ½" S.S. PENTA HEAD BOLT AND 12" S. S. FLAT WASHER" is revised to read; "12 – 13 x 1 ½" S.S. PENTA HEAD BOLT AND 1/2" (IN) S. S. FLAT WASHER"

J-40.36

Note 1, second sentence: "Finish shall be # 2B for backbox and # 4 for the cover." Is revised to read: "Finish shall be # 2B for barrier box and HRAP (Hot Rolled Annealed and Pickled) for the cover.

J-40.37

Note 1, second sentence: "Finish shall be # 2B for backbox and # 4 for the cover." Is revised to read: "Finish shall be # 2B for barrier box and HRAP (Hot Rolled Annealed and Pickled) for the cover.

J-75.20

Key Notes, note 16, second bullet point, was: "1/2" (IN) x 0.45" (IN) Stainless Steel Bands", add the following to the end of the note: "Alternate: Stainless steel cable with stainless steel ends, nuts, bolts, and washers may be used in place of stainless steel bands and associated hardware."

J-75.41

DELETED

K-80.20

DELETED

L-5.10

Sheet 2, Typical Elevation, callout – "2' – 0" MIN. LAP SPLICE BETWEEN (mark) A #3 BAR AND WALL REINFORCEMENT ~ TYPICAL" is revised to read: "2' – 0" MIN. LAP SPLICE BETWEEN (MARK) A #4 BAR AND WALL REINFORCEMENT ~ TYPICAL"

Section C, callout; "(mark) A #3 is revised to read: "(mark) A #4", callout – "(mark) B #3" is revised to read: "(mark) B #4", callout – "(mark) C #3 TIE" is revised to read: "(mark) C #4 TIE"

Reinforcing Steel Bending Diagram, (mark) B detail, callout – "128 deg." is revised to read: "123 deg.", callout – "51 deg." is revised to read: "57 deg."

The following are the Standard Plan numbers applicable at the time this project was advertised. The date shown with each plan number is the publication approval date shown in the lower right-hand corner of that plan. Standard Plans showing different dates shall not be used in this contract.

A-10.10-00.....8/7/07	A-30.35-00.....10/12/07	A-50.10-01.....8/17/21
A-10.20-00.....10/5/07	A-40.00-01.....7/6/22	A-50.40-01..... 8/17/21
A-10.30-00.....10/5/07	A-40.10-04.....7/31/19	A-60.10-03.....12/23/14
A-20.10-00.....8/31/07	A-40.15-00.....8/11/09	A-60.20-03.....12/23/14
A-30.10-00.....11/8/07	A-40.20-04.....1/18/17	A-60.30-01.....6/28/18

A-30.30-01.....6/16/11	A-40.50-02.....12/23/14	A-60.40-00.....8/31/07
B-5.20-03.....9/9/20	B-30.50-03.....2/27/18	B-75.20-03.....8/17/21
B-5.40-02.....1/26/17	B-30.60-00.....9/9/20	B-75.50-01.....6/10/08
B-5.60-02.....1/26/17	B-30.70-04.....2/27/18	B-75.60-00.....6/8/06
B-10.20-02.....3/2/18	B-30.80-01.....2/27/18	B-80.20-00.....6/8/06
B-10.40-02.....8/17/21	B-30.90-02.....1/26/17	B-80.40-00.....6/1/06
B-10.70-02.....8/17/21	B-35.20-00.....6/8/06	B-85.10-01.....6/10/08
B-15.20-01.....2/7/12	B-35.40-00.....6/8/06	B-85.20-00.....6/1/06
B-15.40-01.....2/7/12	B-40.20-00.....6/1/06	B-85.30-00.....6/1/06
B-15.60-02.....1/26/17	B-40.40-02.....1/26/17	B-85.40-00.....6/8/06
B-20.20-02.....3/16/12	B-45.20-01.....7/11/17	B-85.50-01.....6/10/08
B-20.40-04.....2/27/18	B-45.40-01.....7/21/17	B-90.10-00.....6/8/06
B-20.60-03.....3/15/12	B-50.20-00.....6/1/06	B-90.20-00.....6/8/06
B-25.20-02.....2/27/18	B-55.20-03.....8/17/21	B-90.30-00.....6/8/06
B-25.60-02.....2/27/18	B-60.20-02.....9/9/20	B-90.40-01.....1/26/17
B-30.05-00.....9/9/20	B-60.40-01.....2/27/18	B-90.50-00.....6/8/06
B-30.10-03.....2/27/18	B-65.20-01.....4/26/12	B-95.20-02.....8/17/21
B-30.15-00.....2/27/18	B-65.40-00.....6/1/06	B-95.40-01.....6/28/18
B-30.20-04.....2/27/18	B-70.20-00.....3/15/22	
B-30.30-03.....2/27/18	B-70.60-01.....1/26/17	
B-30.40-03.....2/27/18		
C-1.....9/8/22	C-22.40-09.....9/8/22	C-60.70-01.....9/8/22
C-1b.....9/8/22	C-22.45-06.....9/8/22	C-60.80-01.....9/8/22
C-1d.....10/31/03	C-23.70-00.....8/22/22	C-70.15-00.....8/17/21
C-2c.....8/12/19	C-24.10-03.....7/24/22	C-70.10-03.....8/17/21
C-4f.....8/12/19	C-24.15-00.....3/15/22	C-75.10-02.....9/16/20
C-6a.....9/8/22	C-25.20-07.....8/20/21	C-75.20-03.....8/20/21
C-7.....9/8/22	C-25.22-06.....8/20/21	C-75.30-03.....8/21/20
C-7a.....9/8/22	C-25.26-05.....8/20/21	C-80.10-02.....9/16/20
C-20.10-08.....9/8/22	C-25.30-01.....8/20/21	C-80.20-01.....6/11/14
C-20.14-05.....9/8/22	C-25.80-05.....8/12/19	C-80.30-02.....8/20/21
C-20.15-02.....6/11/14	C-60.10-02.....9/8/22	C-80.40-01.....6/11/14
C-20.18-04.....9/8/22	C-60.15-00.....8/17/21	C-85.10-00.....4/8/12
C-20.40-09.....9/8/22	C-60.20-01.....9/8/22	C-85.11-01.....9/16/20
C-20.41-04.....8/22/22	C-60.30-01.....8/17/21	C-85.15-02.....8/27/21
C-20.42-05.....7/14/15	C-60.40-00.....8/17/21	C-85-18-03.....9/8/22
C-20.43-00.....8/22/22	C-60.45-00.....8/17/21	
C-20.45.03.....9/8/22	C-60.50-00.....8/17/21	
C-22.16-07.....9/16/20	C-60.60-00.....8/17/21	
D-2.36-03.....6/11/14	D-4.....12/11/98	D-10.35-00.....7/8/08
D-2.46-02.....8/13/21	D-6.....6/19/98	D-10.40-01.....12/2/08
D-2.84-00.....11/10/05	D-10.10-01.....12/2/08	D-10.45-01.....12/2/08
D-2.92-01.....4/26/22	D-10.15-01.....12/2/08	
D-3.09-00.....5/17/12	D-10.20-01.....8/7/19	
D-3.10-01.....5/29/13	D-10.25-01.....8/7/19	
D-3.11-03.....6/11/14	D-10.30-00.....7/8/08	
E-1.....2/21/07	E-4.....8/27/03	

E-2.....5/29/98	E-4a.....8/27/03	
F-10.12-04.....9/24/20	F-10.62-02.....4/22/14	F-40.15-04.....9/25/20
F-10.16-00.....12/20/06	F-10.64-03.....4/22/14	F-40.16-03.....6/29/16
F-10.18-03.....3/28/22	F-30.10-04.....9/25/20	F-45.10-03.....8/13/21
F-10.40-04.....9/24/20	F-40.12-03.....6/29/16	F-80.10-04.....7/15/16
F-10.42-00.....1/23/07	F-40.14-03.....6/29/16	
G-10.10-00.....9/20/07	G-26.10-00.....7/31/19	
G-20.10-03.....8/20/21	G-30.10-04.....6/23/15	
G-22.10-04.....6/28/18	G-50.10-03.....6/28/18	
G-24.10-00.....11/8/07	G-90.10-03.....7/11/17	
G-24.20-01.....2/7/12	G-90.20-05.....7/11/17	
G-24.30-02.....6/28/18	G-90.30-04.....7/11/17	
G-24.40-07.....6/28/18	G-95.10-02.....6/28/18	
G-24.50-05.....8/7/19	G-95.20-03.....6/28/18	
G-24.60-05.....6/28/18	G-95.30-03.....6/28/18	
G-25.10-05.....9/16/20		
H-10.10-00.....7/3/08	H-32.10-00.....9/20/07	H-70.10-02.....8/17/21
H-10.15-00.....7/3/08	H-60.10-01.....7/3/08	H-70.20-02.....8/17/21
H-30.10-00.....10/12/07	H-60.20-01.....7/3/08	
I-10.10-01.....8/11/09	I-30.20-00.....9/20/07	I-40.20-00.....9/20/07
I-30.10-02.....3/22/13	I-30.30-02.....6/12/19	I-50.20-01.....6/10/13
I-30.15-02.....3/22/13	I-30.40-02.....6/12/19	I-60.10-01.....6/10/13
I-30.16-01.....7/11/19	I-30.60-02.....6/12/19	I-60.20-01.....6/10/13
I-30.17-01.....6/12/19	I-40.10-00.....9/20/07	I-80.10-02.....7/15/16
J-05.50-00.....8/30/22	J-28.10-02.....8/7/19	J-50.25-00.....6/3/11
J-10.....7/18/97	J-28.22-00.....8/07/07	J-50.30-00.....6/3/11
J-10.10-04.....9/16/20	J-28.24-02.....9/16/20	J-60.05-01.....7/21/16
J-10.12-00.....9/16/20	J-28.26-01.....12/02/08	J-60.11-00.....5/20/13
J-10.14-00.....9/16/20	J-28.30-03.....6/11/14	J-60.12-00.....5/20/13
J-10.15-01.....6/11/14	J-28.40-02.....6/11/14	J-60.13-00.....6/16/10
J-10.16-02.....8/18/21	J-28.42-01.....6/11/14	J-60.14-01.....7/31/19
J-10.17-02.....8/18/21	J-28.43-01.....6/28/18	J-75.10-02.....7/10/15
J-10.18-02.....8/18/21	J-28.45-03.....7/21/16	J-75.20-01.....7/10/15
J-10.20-04.....8/18/21	J-28.50-03.....7/21/16	J-75.30-02.....7/10/15
J-10.21-02.....8/18/21	J-28.60-03.....8/27/21	J-75.50-00.....8/30/22
J-10.22-02.....8/18/21	J-28.70-04.....8/30/22	J-75.55-00.....8/30/22
J-10.25-00.....7/11/17	J-29.10-02.....8/26/22	J-80.05-00.....8/30/22
J-10.26-00.....8/30/22	J-29.15-01.....7/21/16	J-80.10-01.....8/18/21
J-12.15-00.....6/28/18	J-29.16-02.....7/21/16	J-80.12-00.....8/18/21
J-12.16-00.....6/28/18	J-30.10-01.....8/26/22	J-80.15-00.....6/28/18
J-15.10-01.....6/11/14	J-40.01-00.....8/30/22	J-81.10-02.....8/18/21
J-15.15-02.....7/10/15	J-40.05-00.....7/21/16	J-81.12-00.....9/3/21
J-20.01-00.....8/30/22	J-40.10-04.....4/28/16	J-84.05-00.....8/30/22
J-20.10-04.....7/31/19	J-40.20-03.....4/28/16	J-86.10-00.....6/28/18
J-20.11-03.....7/31/19	J-40.30-04.....4/28/16	J-90.10-03.....6/28/18
J-20.15-03.....6/30/14	J-40.35-01.....5/29/13	J-90.20-03.....6/28/18

J-20.16-02.....6/30/14  
J-20.20-02.....5/20/13  
J-20.26-01.....7/12/12  
J-21.10-04.....6/30/14  
J-21.15-01.....6/10/13  
J-21.16-01.....6/10/13  
J-21.17-01.....6/10/13  
J-21.20-01.....6/10/13  
J-22.15-02.....7/10/15  
J-22.16-03.....7/10/15  
J-26.10-03.....7/21/16  
J-26.15-01.....5/17/12  
J-26.20-01.....6/28/18  
J-27.10-01.....7/21/16  
J-27.15-00.....3/15/12  
J-28.01-00.....8/30/22

J-40.36-02.....7/21/17  
J-40.37-02.....7/21/17  
J-40.38-01.....5/20/13  
J-40.39-00.....5/20/13  
J-40.40-02.....7/31/19  
J-45.36-00.....7/21/17  
J-50.05-00.....7/21/17  
J-50.10-01.....7/31/19  
J-50.11-02.....7/31/19  
J-50.12-02.....8/7/19  
J-50.13-01.....8/30/22  
J-50.15-01.....7/21/17  
J-50.16-01.....3/22/13  
J-50.18-00.....8/7/19  
J-50.19-00.....8/7/19  
J-50.20-00.....6/3/11

J-90.21-02.....6/28/18  
J-90.50-00.....6/28/18

K-70.20-01.....6/1/16  
K-80.10-02.....9/25/20

K-80.32-00.....8/17/21  
K-80.34-00.....8/17/21

K-80.35-01.....9/16/20  
K-80.37-01.....9/16/20

L-5.10-00.....9/19/22  
L-5.15-00.....9/19/22  
L-10.10-02.....6/21/12

L-20.10-03.....7/14/15  
L-30.10-02.....6/11/14  
L-40.15-01.....6/16/11

L-40.20-02.....6/21/12  
L-70.10-01.....5/21/08  
L-70.20-01.....5/21/08

M-1.20-04.....9/25/20  
M-1.40-03.....9/25/20  
M-1.60-03.....9/25/20  
M-1.80-03.....6/3/11  
M-2.20-03.....7/10/15  
M-2.21-00.....7/10/15  
M-3.10-04.....9/25/20  
M-3.20-04.....8/2/22  
M-3.30-04.....9/25/20  
M-3.40-04.....9/25/20  
M-3.50-03.....9/25/20  
M-5.10-03.....9/25/20  
M-7.50-01.....1/30/07  
M-9.50-02.....6/24/14  
M-9.60-00.....2/10/09

M-11.10-04.....8/2/22  
M-12.10-03.....8/2/22  
M-15.10-01.....2/6/07  
M-17.10-02.....7/3/08  
M-20.10-04.....8/2/22  
M-20.20-02.....4/20/15  
M-20.30-04.....2/29/16  
M-20.40-03.....6/24/14  
M-20.50-02.....6/3/11  
M-24.20-02.....4/20/15  
M-24.40-02.....4/20/15  
M-24.60-04.....6/24/14  
M-24.65-00.....7/11/17  
M-24.66-00.....7/11/17  
M-40.10-03.....6/24/14

M-40.20-00...10/12/07  
M-40.30-01.....7/11/17  
M-40.40-00.....9/20/07  
M-40.50-00.....9/20/07  
M-40.60-00.....9/20/07  
M-60.10-01.....6/3/11  
M-60.20-03.....8/17/21  
M-65.10-03.....8/17/21  
M-80.10-01.....6/3/11  
M-80.20-00.....6/10/08  
M-80.30-00.....6/10/08

## END DIVISION 9

---

---

***APPENDIX A***  
***PREVAILING WAGES***

---

---

\*\*\*\*\*

**Overtime Codes**

**Overtime calculations** are based on the hourly rate actually paid to the worker. On public works projects, the hourly rate must be not less than the prevailing rate of wage minus the hourly rate of the cost of fringe benefits actually provided for the worker.

1. ALL HOURS WORKED IN EXCESS OF EIGHT (8) HOURS PER DAY OR FORTY (40) HOURS PER WEEK SHALL BE PAID AT ONE AND ONE-HALF TIMES THE HOURLY RATE OF WAGE.
  - B. All hours worked on Saturdays shall be paid at one and one-half times the hourly rate of wage. All hours worked on Sundays and holidays shall be paid at double the hourly rate of wage.
  - C. The first two (2) hours after eight (8) regular hours Monday through Friday and the first ten (10) hours on Saturday shall be paid at one and one-half times the hourly rate of wage. All other overtime hours and all hours worked on Sundays and holidays shall be paid at double the hourly rate of wage.
  - D. The first two (2) hours before or after a five-eight (8) hour workweek day or a four-ten (10) hour workweek day and the first eight (8) hours worked the next day after either workweek shall be paid at one and one-half times the hourly rate of wage. All additional hours worked and all worked on Sundays and holidays shall be paid at double the hourly rate of wage.
  - E. The first two (2) hours after eight (8) regular hours Monday through Friday and the first eight (8) hours on Saturday shall be paid at one and one-half times the hourly rate of wage. All other hours worked Monday through Saturday, and all hours worked on Sundays and holidays shall be paid at double the hourly rate of wage.
  - F. The first two (2) hours after eight (8) regular hours Monday through Friday and the first ten (10) hours on Saturday shall be paid at one and one-half times the hourly rate of wage. All other overtime hours worked, except Labor Day, shall be paid at double the hourly rate of wage. All hours worked on Labor Day shall be paid at three times the hourly rate of wage.
  - G. The first ten (10) hours worked on Saturdays and the first ten (10) hours worked on a fifth calendar weekday in a four-ten hour schedule, shall be paid at one and one-half times the hourly rate of wage. All hours worked in excess of ten (10) hours per day Monday through Saturday and all hours worked on Sundays and holidays shall be paid at double the hourly rate of wage.
  - H. All hours worked on Saturdays (except makeup days if work is lost due to inclement weather conditions or equipment breakdown) shall be paid at one and one-half times the hourly rate of wage. All hours worked Monday through Saturday over twelve (12) hours and all hours worked on Sundays and holidays shall be paid at double the hourly rate of wage.
  - I. All hours worked on Sundays and holidays shall also be paid at double the hourly rate of wage.
  - J. The first two (2) hours after eight (8) regular hours Monday through Friday and the first ten (10) hours on Saturday shall be paid at one and one-half times the hourly rate of wage. All hours worked over ten (10) hours Monday through Saturday, Sundays and holidays shall be paid at double the hourly rate of wage.
  - K. All hours worked on Saturdays and Sundays shall be paid at one and one-half times the hourly rate of wage. All hours worked on holidays shall be paid at double the hourly rate of wage.
  - M. All hours worked on Saturdays (except makeup days if work is lost due to inclement weather conditions) shall be paid at one and one-half times the hourly rate of wage. All hours worked on Sundays and holidays shall be paid at double the hourly rate of wage.
  - N. All hours worked on Saturdays (except makeup days) shall be paid at one and one-half times the hourly rate of wage. All hours worked on Sundays and holidays shall be paid at double the hourly rate of wage.

**Overtime Codes Continued**

1. O. The first ten (10) hours worked on Saturday shall be paid at one and one-half times the hourly rate of wage. All hours worked on Sundays, holidays and after twelve (12) hours, Monday through Friday and after ten (10) hours on Saturday shall be paid at double the hourly rate of wage.
- P. All hours worked on Saturdays (except makeup days if circumstances warrant) and Sundays shall be paid at one and one-half times the hourly rate of wage. All hours worked on holidays shall be paid at double the hourly rate of wage.
- Q. The first two (2) hours after eight (8) regular hours Monday through Friday and up to ten (10) hours worked on Saturdays shall be paid at one and one-half times the hourly rate of wage. All hours worked in excess of ten (10) hours per day Monday through Saturday and all hours worked on Sundays and holidays (except Christmas day) shall be paid at double the hourly rate of wage. All hours worked on Christmas day shall be paid at two and one-half times the hourly rate of wage.
- R. All hours worked on Sundays and holidays shall be paid at two times the hourly rate of wage.
- U. All hours worked on Saturdays shall be paid at one and one-half times the hourly rate of wage. All hours worked on Sundays and holidays (except Labor Day) shall be paid at two times the hourly rate of wage. All hours worked on Labor Day shall be paid at three times the hourly rate of wage.
- V. All hours worked on Sundays and holidays (except Thanksgiving Day and Christmas day) shall be paid at one and one-half times the hourly rate of wage. All hours worked on Thanksgiving Day and Christmas day shall be paid at double the hourly rate of wage.
- W. All hours worked on Saturdays and Sundays (except make-up days due to conditions beyond the control of the employer) shall be paid at one and one-half times the hourly rate of wage. All hours worked on holidays shall be paid at double the hourly rate of wage.
- X. The first four (4) hours after eight (8) regular hours Monday through Friday and the first twelve (12) hours on Saturday shall be paid at one and one-half times the hourly rate of wage. All hours worked over twelve (12) hours Monday through Saturday, Sundays and holidays shall be paid at double the hourly rate of wage. When holiday falls on Saturday or Sunday, the day before Saturday, Friday, and the day after Sunday, Monday, shall be considered the holiday and all work performed shall be paid at double the hourly rate of wage.
- Y. All hours worked outside the hours of 5:00 am and 5:00 pm (or such other hours as may be agreed upon by any employer and the employee) and all hours worked in excess of eight (8) hours per day (10 hours per day for a 4 x 10 workweek) and on Saturdays and holidays (except labor day) shall be paid at one and one-half times the hourly rate of wage. (except for employees who are absent from work without prior approval on a scheduled workday during the workweek shall be paid at the straight-time rate until they have worked 8 hours in a day (10 in a 4 x 10 workweek) or 40 hours during that workweek.) All hours worked Monday through Saturday over twelve (12) hours and all hours worked on Sundays and Labor Day shall be paid at double the hourly rate of wage.
- Z. All hours worked on Saturdays and Sundays shall be paid at one and one-half times the hourly rate of wage. All hours worked on holidays shall be paid the straight time rate of pay in addition to holiday pay.

**Overtime Codes Continued**

2. ALL HOURS WORKED IN EXCESS OF EIGHT (8) HOURS PER DAY OR FORTY (40) HOURS PER WEEK SHALL BE PAID AT ONE AND ONE-HALF TIMES THE HOURLY RATE OF WAGE.

- B. All hours worked on holidays shall be paid at one and one-half times the hourly rate of wage.
- F. The first eight (8) hours worked on holidays shall be paid at the straight hourly rate of wage in addition to the holiday pay. All hours worked in excess of eight (8) hours on holidays shall be paid at double the hourly rate of wage.
- M. This code appears to be missing. All hours worked on Saturdays, Sundays and holidays shall be paid at double the hourly rate of wage.
- O. All hours worked on Sundays and holidays shall be paid at one and one-half times the hourly rate of wage.
- R. All hours worked on Sundays and holidays and all hours worked over sixty (60) in one week shall be paid at double the hourly rate of wage.
- U. All hours worked on Saturdays shall be paid at one and one-half times the hourly rate of wage. All hours worked over 12 hours in a day or on Sundays and holidays shall be paid at double the hourly rate of wage.

3. ALL HOURS WORKED IN EXCESS OF EIGHT (8) HOURS PER DAY OR FORTY (40) HOURS PER WEEK SHALL BE PAID AT ONE AND ONE-HALF TIMES THE HOURLY RATE OF WAGE.

- F. All hours worked on Saturday shall be paid at one and one-half times the hourly rate of wage. All hours worked on Sunday shall be paid at two times the hourly rate of wage. All hours worked on paid holidays shall be paid at two and one-half times the hourly rate of wage including holiday pay.
- H. All work performed on Sundays between March 16th and October 14th and all Holidays shall be compensated for at two (2) times the regular rate of pay. Work performed on Sundays between October 15th and March 15th shall be compensated at one and one half (1-1/2) times the regular rate of pay.
- J. All hours worked between the hours of 10:00 pm and 5:00 am, Monday through Friday, and all hours worked on Saturdays shall be paid at a one and one-half times the hourly rate of wage. All hours worked on Sundays and holidays shall be paid at double the hourly rate of wage.
- K. Work performed in excess of eight (8) hours of straight time per day, or ten (10) hours of straight time per day when four ten (10) hour shifts are established, or forty (40) hours of straight time per week, Monday through Friday, or outside the normal 5 am to 6pm shift, and all work on Saturdays shall be paid at one and one-half times the hourly rate of wage. All work performed after 6:00 pm Saturday to 5:00 am Monday and Holidays, and all hours worked in excess of twelve (12) hours in a single shift shall be paid at double the hourly rate of wage.

After an employee has worked eight (8) hours at an applicable overtime rate, all additional hours shall be at the applicable overtime rate until such time as the employee has had a break of eight (8) hours or more. When an employee returns to work without at least eight (8) hours time off since their previous shift, all such time shall be a continuation of shift and paid at the applicable overtime rate until he/she shall have the eight (8) hours rest period.

4. ALL HOURS WORKED IN EXCESS OF EIGHT (8) HOURS PER DAY OR FORTY (40) HOURS PER WEEK SHALL BE PAID AT ONE AND ONE-HALF TIMES THE HOURLY RATE OF WAGE.

- A. All hours worked in excess of eight (8) hours per day or forty (40) hours per week shall be paid at double the hourly rate of wage. All hours worked on Saturdays, Sundays and holidays shall be paid at double the hourly rate of wage.



**Overtime Codes Continued**

4. C. On Monday through Friday, the first four (4) hours of overtime after eight (8) hours of straight time work shall be paid at one and one half (1-1/2) times the straight time rate of pay, unless a four (4) day ten (10) hour workweek has been established. On a four (4) day ten (10) hour workweek scheduled Monday through Thursday, or Tuesday through Friday, the first two (2) hours of overtime after ten (10) hours of straight time work shall be paid at one and one half (1-1/2) times the straight time rate of pay. On Saturday, the first twelve (12) hours of work shall be paid at one and one half (1-1/2) times the straight time rate of pay, except that if the job is down on Monday through Friday due to weather conditions or other conditions outside the control of the employer, the first ten (10) hours on Saturday may be worked at the straight time rate of pay. All hours worked over twelve (12) hours in a day and all hours worked on Sunday and Holidays shall be paid at two (2) times the straight time rate of pay.

D. All hours worked in excess of eight (8) hours per day or forty (40) hours per week shall be paid at double the hourly rate of wage. All hours worked on Saturday, Sundays and holidays shall be paid at double the hourly rate of pay. Rates include all members of the assigned crew.

**EXCEPTION:**

On all multipole structures and steel transmission lines, switching stations, regulating, capacitor stations, generating plants, industrial plants, associated installations and substations, except those substations whose primary function is to feed a distribution system, will be paid overtime under the following rates:

The first two (2) hours after eight (8) regular hours Monday through Friday of overtime on a regular workday, shall be paid at one and one-half times the hourly rate of wage. All hours in excess of ten (10) hours will be at two (2) times the hourly rate of wage. The first eight (8) hours worked on Saturday will be paid at one and one-half (1-1/2) times the hourly rate of wage. All hours worked in excess of eight (8) hours on Saturday, and all hours worked on Sundays and holidays will be at the double the hourly rate of wage.

All overtime eligible hours performed on the above described work that is energized, shall be paid at the double the hourly rate of wage.

E. The first two (2) hours after eight (8) regular hours Monday through Friday and the first eight (8) hours on Saturday shall be paid at one and one-half times the hourly rate of wage. All other hours worked Monday through Saturday, and all hours worked on Sundays and holidays shall be paid at double the hourly rate of wage.

On a four-day, ten-hour weekly schedule, either Monday thru Thursday or Tuesday thru Friday schedule, all hours worked after ten shall be paid at double the hourly rate of wage. The Monday or Friday not utilized in the normal four-day, ten hour work week, and Saturday shall be paid at one and one half (1½) times the regular shift rate for the first eight (8) hours. All other hours worked Monday through Saturday, and all hours worked on Sundays and holidays shall be paid at double the hourly rate of wage.

G. All hours worked on Saturdays shall be paid at one and one-half times the hourly rate of wage. All hours worked Monday through Saturday over twelve (12) hours and all hours worked on Sundays and holidays shall be paid at double the hourly rate of wage.

I. The First eight (8) hours worked on Saturdays shall be paid at one and one-half times the hourly rate of wage. All hours worked in excess of eight (8) per day on Saturdays shall be paid at double the hourly rate of wage. All hours worked on Sundays and holidays shall be paid at double the hourly rate of wage.

**Overtime Codes Continued**

4. J. The first eight (8) hours worked on a Saturday shall be paid at one and one-half times the hourly rate of wage. All hours worked in excess of eight (8) hours on a Saturday shall be paid at double the hourly rate of wage. All hours worked over twelve (12) in a day, and all hours worked on Sundays and Holidays shall be paid at double the hourly rate of wage.
- K. All hours worked on a Saturday shall be paid at one and one-half times the hourly rate of wage, so long as Saturday is the sixth consecutive day worked. All hours worked over twelve (12) in a day Monday through Saturday, and all hours worked on Sundays and Holidays shall be paid at double the hourly rate of wage.
- L. The first twelve (12) hours worked on a Saturday shall be paid at one and one-half times the hourly rate of wage. All hours worked on a Saturday in excess of twelve (12) hours shall be paid at double the hourly rate of pay. All hours worked over twelve (12) in a day Monday through Friday, and all hours worked on Sundays shall be paid at double the hourly rate of wage. All hours worked on a holiday shall be paid at one and one-half times the hourly rate of wage, except that all hours worked on Labor Day shall be paid at double the hourly rate of pay.
- S. On a four (4) day ten (10) hour workweek scheduled Monday through Thursday, or Tuesday through Friday, work performed in excess of (10) hours shall be paid at one and one half (1-1/2) times the hourly rate of pay. On Monday through Friday, work performed outside the normal work hours of 6:00 a.m. and 6:00 p.m. shall be paid at one and one-half (1-1/2) times the straight time rate, (except for special shifts or multiple shift operations).
- All hours worked on Saturdays shall be paid at one and one-half times the hourly rate of wage. All work performed on Sundays and holidays shall be paid at double the hourly rate of wage.
- When an employee returns to work without at least eight (8) hours time off since their previous shift, all such time shall be a continuation of shift and paid at the applicable overtime rate until such time as the employee has had a break of eight (8) hours.
- Multiple Shift Operations: When the first shift of a multiple shift (a two or three shift) operation is started at the basic straight time rate or at a specific overtime rate, all shifts of that day's operation shall be completed at that rate.
- Special Shifts: The Special Shift Premium is the basic hourly rate of pay plus \$2.00 an hour. When due to conditions beyond the control of the employer or when an owner (not acting as the contractor), a government agency or the contract specifications require more than four (4) hours of a special shift can only be performed outside the normal 6am to 6pm shift then the special shift premium will be applied to the basic straight time for the entire shift. When an employee works on a special shift, they shall be paid the special shift premium for each hour worked unless they are in overtime or double-time status. (For example, the special shift premium does not waive the overtime requirements for work performed on Saturday or Sunday).
- U. The first four (4) hours after eight (8) regular hours Monday through Friday and the first twelve (12) hours on Saturday shall be paid at one and one-half times the hourly rate of wage. (Except on makeup days if work is lost due to inclement weather, then the first eight (8) hours on Saturday may be paid the regular rate.) All hours worked over twelve (12) hours Monday through Saturday, and all hours worked on Sundays and holidays shall be paid at double the hourly rate of wage.

**Overtime Codes Continued**

4. V. Work performed in excess of ten (10) hours of straight time per day when four ten (10) hour shifts are established or outside the normal shift (5 am to 6pm), and all work on Saturdays, except for make-up days shall be paid at time and one-half (1 ½) the straight time rate.

In the event the job is down due to weather conditions, then Saturday may, be worked as a voluntary make-up day at the straight time rate. However, Saturday shall not be utilized as a make-up day when a holiday falls on Friday. All work performed on Sundays and holidays and work in excess of twelve (12) hours per day shall be paid at double (2x) the straight time rate of pay.

After an employee has worked eight (8) hours at an applicable overtime rate, all additional hours shall be at the applicable overtime rate until such time as the employee has had a break of eight (8) hours.

When an employee returns to work without a break of eight (8) hours since their previous shift, all such time shall be a continuation of shift and paid at the applicable overtime rate until such time as the employee has had a break of eight (8) hours.

- W. All hours worked on Saturdays (except makeup days if work is lost due to inclement weather conditions) shall be paid at one and one-half times the hourly rate of wage. All hours worked on Sundays and holidays shall be paid at double the hourly rate of wage.

When an employee returns to work without at least eight (8) hours time off since their previous shift, all such time shall be a continuation of shift and paid at the applicable overtime rate until such time as the employee has had a break of eight (8) hours.

- X. All hours worked on Saturdays shall be paid at one and one-half times the hourly rate of wage. All hours worked on Sundays and holidays shall be paid at double the hourly rate of wage. Work performed outside the normal shift of 6 am to 6pm shall be paid at one and one-half the straight time rate, (except for special shifts or three shift operations). All work performed on Sundays and holidays shall be paid at double the hourly rate of wage. Shifts may be established when considered necessary by the Employer.

The Employer may establish shifts consisting of eight (8) or ten (10) hours of work (subject to WAC 296-127-022), that shall constitute a normal forty (40) hour work week. The Employer can change from a 5-eight to a 4-ten hour schedule or back to the other. All hours of work on these shifts shall be paid for at the straight time hourly rate. Work performed in excess of eight hours (or ten hours per day (subject to WAC 296-127-022) shall be paid at one and one-half the straight time rate.

When due to conditions beyond the control of the Employer, or when contract specifications require that work can only be performed outside the regular day shift, then by mutual agreement a special shift may be worked at the straight time rate, eight (8) hours work for eight (8) hours pay. The starting time shall be arranged to fit such conditions of work.

When an employee returns to work without a break of eight (8) hours since their previous shift, all such time shall be a continuation of shift and paid at the applicable overtime rate until such time as the employee has had a break of eight (8) hours.

- Y. Work performed in excess of eight (8) hours of straight time per day, or ten (10) hours of straight time per day when four ten (10) hour shifts are established, or forty (40) hours of straight time per week, Monday through Friday, or outside the normal shift, and all work on Saturdays shall be paid at time and one-half the straight time rate. All work performed after 6:00 pm Saturday to 6:00 am Monday and holidays shall be paid at double the straight time rate of pay.

Any shift starting between the hours of 6:00 pm and midnight shall receive an additional one dollar (\$1.00) per hour for all hours worked that shift.

After an employee has worked eight (8) hours at an applicable overtime rate, all additional hours shall be at the applicable overtime rate until such time as the employee has had a break of eight (8) hours or more.

**Overtime Codes Continued**

11. ALL HOURS WORKED IN EXCESS OF EIGHT (8) HOURS PER DAY OR FORTY (40) HOURS PER WEEK SHALL BE PAID AT ONE AND ONE-HALF TIMES THE HOURLY RATE OF WAGE.

B After an employee has worked eight (8) hours, all additional hours worked shall be paid at the applicable overtime rate until such time as the employee has had a break of eight (8) hours or more.

C The first two (2) hours after eight (8) regular hours Monday through Friday and the first eight (8) hours on Saturday shall be paid at one and one-half times the hourly rate of wage. All other overtime hours worked, except Labor Day, and all hours on Sunday shall be paid at double the hourly rate of wage. All hours worked on Labor Day shall be paid at three times the hourly rate of wage. All non-overtime and non-holiday hours worked between 4:00 pm and 5:00 am, Monday through Friday, shall be paid at a premium rate of 15% over the hourly rate of wage.

D. All hours worked on Saturdays and holidays shall be paid at one and one-half times the hourly rate of wage. All hours worked on Sundays shall be paid at double the hourly rate of wage.

After an employee has worked eight (8) hours, all additional hours worked shall be paid at the applicable overtime rate until such time as the employee has had a break of eight (8) hours or more.

E. The first two (2) hours after eight (8) regular hours Monday through Friday, the first ten (10) hours on Saturday, and the first ten (10) hours worked on Holidays shall be paid at one and one-half times the hourly rate of wage. All hours worked over ten (10) hours Monday through Saturday, and Sundays shall be paid at double the hourly rate of wage.

After an employee has worked eight (8) hours, all additional hours worked shall be paid at the applicable overtime rate until such time as the employee has had a break of eight (8) hours or more.

F. The first two (2) hours after eight (8) regular hours Monday through Friday and the first eight (8) hours on Saturday shall be paid at one and one-half times the hourly rate of wage. All other hours worked Monday through Saturday, and all hours worked on Sundays and holidays shall be paid at double the hourly rate of wage.

On a four-day, ten-hour weekly schedule, either Monday thru Thursday or Tuesday thru Friday schedule, all hours worked after ten shall be paid at double the hourly rate of wage. The Monday or Friday not utilized in the normal four-day, ten hour work week, and Saturday shall be paid at one-half times the hourly rate of wage for the first eight (8) hours. All other hours worked Monday through Saturday, and all hours worked on Sundays and holidays shall be paid at double the hourly rate of wage.

G. Work performed in excess of eight (8) hours of straight time per day, or ten (10) hours of straight time per day when four ten (10) hour shifts are established, or forty (40) hours of straight time per week, Monday through Friday, or outside the normal 5 am to 6pm shift, and all work on Saturdays shall be paid at one and one-half times the hourly rate of wage.

All work performed after 6:00 pm Saturday to 5:00 am Monday and Holidays, and all hours worked in excess of twelve (12) hours in a single shift shall be paid at double the hourly rate of wage.

After an employee has worked eight (8) hours at an applicable overtime rate, all additional hours shall be at the applicable overtime rate until such time as the employee has had a break of nine (9) hours or more. When an employee returns to work without at least nine (9) hours time off since their previous shift, all such time shall be a continuation of shift and paid at the applicable overtime rate until he/she shall have the nine (9) hours rest period.

**Overtime Codes Continued**

11. H. Work performed in excess of eight (8) hours of straight time per day, or ten (10) hours of straight time per day when four ten (10) hour shifts are established, or forty (40) hours of straight time per week, Monday through Friday, or outside the normal 5 am to 6pm shift, and all work on Saturdays shall be paid at one and one-half times the hourly rate of wage.

All work performed after 6:00 pm Saturday to 5:00 am Monday and Holidays, and all hours worked in excess of twelve (12) hours in a single shift shall be paid at double the hourly rate of wage.

After an employee has worked eight (8) hours at an applicable overtime rate, all additional hours shall be at the applicable overtime rate until such time as the employee has had a break of ten (10) hours or more. When an employee returns to work without at least ten (10) hours time off since their previous shift, all such time shall be a continuation of shift and paid at the applicable overtime rate until he/she shall have the ten (10) hours rest period.

- I. On Monday through Friday, the first four (4) hours of overtime after eight (8) hours of straight time work shall be paid at one and one half (1-1/2) times the straight time rate of pay, unless a four (4) day ten (10) hour workweek has been established. On a four (4) day ten (10) hour workweek scheduled Monday through Thursday, or Tuesday through Friday, the first two (2) hours of overtime after ten (10) hours of straight time work shall be paid at one and one half (1-1/2) times the straight time rate of pay.

On Saturday, the first twelve (12) hours of work shall be paid at one and one half (1-1/2) times the straight time rate of pay. All work performed after 6:00 pm Saturday to 5:00 am Monday, all work performed over twelve (12) hours, and all work performed on holidays shall be paid at double the straight time rate of pay.

Any shift starting between the hours of 6:00 pm and midnight shall receive an additional two dollar (\$2.00) per hour for all hours worked that shift.

- J. All hours worked on holidays shall be paid at double the hourly rate of wage.

- K. On Monday through Friday hours worked outside 4:00 am and 5:00 pm, and the first two (2) hours after eight (8) hours worked shall be paid at one and one-half times the hourly rate. All hours worked over 10 hours per day Monday through Friday, and all hours worked on Saturdays, Sundays, and Holidays worked shall be paid at double the hourly rate of wage.

- L. An employee working outside 5:00 am and 5:00 pm shall receive an additional two dollar (\$2.00) per hour for all hours worked that shift. All hours worked on holidays shall be paid at one and one-half times the hourly rate of wage. All hours worked on holidays shall be paid at one and one-half times the hourly rate of wage.

- M. On Monday through Friday, the first four (4) hours of overtime after eight (8) hours of straight time work shall be paid at one and one half (1-1/2) times the straight time rate of pay, unless a four (4) day ten (10) hour workweek has been established. On a four (4) day ten (10) hour workweek scheduled Monday through Thursday, or Tuesday through Friday, the first two (2) hours of overtime after ten (10) hours of straight time work shall be paid at one and one half (1-1/2) times the straight time rate of pay.

Work performed outside the normal work hours of 5:00 a.m. and 6:00 p.m. shall be paid at one and one-half (1-1/2) times the straight time rate, (except for special shifts or multiple shift operations). When the first shift of a multiple shift (a two or three shift) operation is started at the basic straight time rate or at a specific overtime rate, all shifts of that day's operation shall be completed at that rate. When due to conditions beyond the control of the Employer or when contract specifications require that work can only be performed outside the regular day shift of 5:00 am to 6:00 pm, then a special shift may be worked at the straight time rate, plus the shift pay premium when applicable. The starting time of work will be arranged to fit such conditions of work. Such shift shall consist of eight (8) hours work for eight (8) hours pay or ten (10) hours work for ten (10) hours pay for four ten shifts.

On Saturday, the first twelve (12) hours of work shall be paid at one and one half (1-1/2) times the straight time rate of pay. All work performed after 6:00 pm Saturday to 5:00 am Monday, all work performed over twelve (12) hours,

Benefit Code Key – Effective 8/31/2022 thru 3/2/2023 (Updates effective on 10/22/2022)

and all work performed on holidays shall be paid at double the straight time rate of pay.

Shift Pay Premium: In an addition to any overtime already required, all hours worked between the hours of 6:00 pm and 5:00 am shall receive an additional two dollars (\$2.00) per hour.

**Holiday Codes**

- 5. A. Holidays: New Year's Day, Memorial Day, Independence Day, Labor Day, Thanksgiving Day, Friday after Thanksgiving Day, and Christmas Day (7).
- B. Holidays: New Year's Day, Memorial Day, Independence Day, Labor Day, Thanksgiving Day, Friday after Thanksgiving Day, the day before Christmas, and Christmas Day (8).
- C. Holidays: New Year's Day, Presidents' Day, Memorial Day, Independence Day, Labor Day, Thanksgiving Day, the Friday after Thanksgiving Day, And Christmas Day (8).
- D. Holidays: New Year's Day, Memorial Day, Independence Day, Labor Day, Thanksgiving Day, the Friday and Saturday after Thanksgiving Day, And Christmas Day (8).
- H. Holidays: New Year's Day, Memorial Day, Independence Day, Thanksgiving Day, the Day after Thanksgiving Day, And Christmas (6).
- I. Holidays: New Year's Day, Memorial Day, Independence Day, Labor Day, Thanksgiving Day, and Christmas Day (6).
- J. Holidays: New Year's Day, Memorial Day, Independence Day, Thanksgiving Day, Friday after Thanksgiving Day, Christmas Eve Day, And Christmas Day (7).
- K. Holidays: New Year's Day, Presidents' Day, Memorial Day, Independence Day, Labor Day, Thanksgiving Day, Friday After Thanksgiving Day, The Day Before Christmas, And Christmas Day (9).

**Holiday Codes Continued**

- 6. L. Holidays: New Year's Day, Martin Luther King Jr. Day, Memorial Day, Independence Day, Labor Day, Thanksgiving Day, Friday after Thanksgiving Day, And Christmas Day (8).
- N. Holidays: New Year's Day, Presidents' Day, Memorial Day, Independence Day, Labor Day, Veterans' Day, Thanksgiving Day, The Friday After Thanksgiving Day, And Christmas Day (9).
- P. Holidays: New Year's Day, Memorial Day, Independence Day, Labor Day, Thanksgiving Day, Friday And Saturday After Thanksgiving Day, The Day Before Christmas, And Christmas Day (9). If A Holiday Falls On Sunday, The Following Monday Shall Be Considered As A Holiday.
- Q. Paid Holidays: New Year's Day, Memorial Day, Independence Day, Labor Day, Thanksgiving Day, and Christmas Day (6).
- R. Paid Holidays: New Year's Day, Memorial Day, Independence Day, Labor Day, Thanksgiving Day, Day After Thanksgiving Day, One-Half Day Before Christmas Day, And Christmas Day. (7 1/2).

**Holiday Codes Continued**

- S. Paid Holidays: New Year's Day, Presidents' Day, Memorial Day, Independence Day, Labor Day, Thanksgiving Day, And Christmas Day (7).
- Z. Holidays: New Year's Day, Memorial Day, Independence Day, Labor Day, Veterans Day, Thanksgiving Day, the Friday after Thanksgiving Day, And Christmas Day (8).
- G. Paid Holidays: New Year's Day, Martin Luther King Jr. Day, Presidents' Day, Memorial Day, Independence Day, Labor Day, Veterans' Day, Thanksgiving Day, the Friday after Thanksgiving Day, Christmas Day, and Christmas Eve Day (11).
- H. Paid Holidays: New Year's Day, New Year's Eve Day, Memorial Day, Independence Day, Labor Day, Thanksgiving Day, Friday After Thanksgiving Day, Christmas Day, The Day After Christmas, And A Floating Holiday (10).
- T. Paid Holidays: New Year's Day, Presidents' Day, Memorial Day, Independence Day, Labor Day, Thanksgiving Day, The Friday After Thanksgiving Day, The Last Working Day Before Christmas Day, And Christmas Day (9).
- Z. Holidays: New Year's Day, Memorial Day, Independence Day, Labor Day, Thanksgiving Day, Friday after Thanksgiving Day, And Christmas Day (7). If a holiday falls on Saturday, the preceding Friday shall be considered as the holiday. If a holiday falls on Sunday, the following Monday shall be considered as the holiday.
- 7. A. Holidays: New Year's Day, Memorial Day, Independence Day, Labor Day, Thanksgiving Day, the Friday and Saturday after Thanksgiving Day, And Christmas Day (8). Any Holiday Which Falls On A Sunday Shall Be Observed As A Holiday On The Following Monday. If any of the listed holidays falls on a Saturday, the preceding Friday shall be a regular work day.
- B. Holidays: New Year's Day, Memorial Day, Independence Day, Labor Day, Thanksgiving Day, the Friday and Saturday after Thanksgiving Day, And Christmas Day (8). Any holiday which falls on a Sunday shall be observed as a holiday on the following Monday. Any holiday which falls on a Saturday shall be observed as a holiday on the preceding Friday.
- C. Holidays: New Year's Day, Martin Luther King Jr. Day, Memorial Day, Independence Day, Labor Day, Thanksgiving Day, the Friday after Thanksgiving Day, And Christmas Day (8). Any holiday which falls on a Sunday shall be observed as a holiday on the following Monday. Any holiday which falls on a Saturday shall be observed as a holiday on the preceding Friday.
- D. Paid Holidays: New Year's Day, Memorial Day, Independence Day, Labor Day, Veteran's Day, Thanksgiving Day, the Friday after Thanksgiving Day, And Christmas Day (8). Unpaid Holidays: President's Day. Any paid holiday which falls on a Sunday shall be observed as a holiday on the following Monday. Any paid holiday which falls on a Saturday shall be observed as a holiday on the preceding Friday.
- E. Holidays: New Year's Day, Memorial Day, Independence Day, Labor Day, Thanksgiving Day, the Friday after Thanksgiving Day, And Christmas Day (7). Any holiday which falls on a Sunday shall be observed as a holiday on the following Monday. Any holiday which falls on a Saturday shall be observed as a holiday on the preceding Friday.
- F. Holidays: New Year's Day, Memorial Day, Independence Day, Labor Day, Thanksgiving Day, the Friday after Thanksgiving Day, the last working day before Christmas day and Christmas day (8). Any holiday which falls on a Sunday shall be observed as a holiday on the following Monday. Any holiday which falls on a Saturday shall be observed as a holiday on the preceding Friday.

**Holiday Codes Continued**

7. G. Holidays: New Year's Day, Memorial Day, Independence Day, Labor Day, Thanksgiving Day, and Christmas Day (6). Any holiday which falls on a Sunday shall be observed as a holiday on the following Monday.
- H. Holidays: New Year's Day, Martin Luther King Jr. Day, Independence Day, Memorial Day, Labor Day, Thanksgiving Day, the Friday after Thanksgiving Day, the Last Working Day before Christmas Day and Christmas Day (9). Any holiday which falls on a Sunday shall be observed as a holiday on the following Monday. Any holiday which falls on a Saturday shall be observed as a holiday on the preceding Friday.
- I. Holidays: New Year's Day, President's Day, Independence Day, Memorial Day, Labor Day, Thanksgiving Day, The Friday After Thanksgiving Day, The Day Before Christmas Day And Christmas Day (9). Any holiday which falls on a Sunday shall be observed as a holiday on the following Monday. Any holiday which falls on a Saturday shall be observed as a holiday on the preceding Friday.
- J. Holidays: New Year's Day, Independence Day, Memorial Day, Labor Day, Thanksgiving Day and Christmas Day (6). Any holiday which falls on a Sunday shall be observed as a holiday on the following Monday. Any holiday which falls on a Saturday shall be observed as a holiday on the preceding Friday.
- K. Holidays: New Year's Day, Memorial Day, Independence Day, Thanksgiving Day, the Friday and Saturday after Thanksgiving Day, And Christmas Day (8). Any holiday which falls on a Sunday shall be observed as a holiday on the following Monday. Any holiday which falls on a Saturday shall be observed as a holiday on the preceding Friday.
- L. Holidays: New Year's Day, Memorial Day, Labor Day, Independence Day, Thanksgiving Day, the Last Work Day before Christmas Day, And Christmas Day (7). Any holiday which falls on a Sunday shall be observed as a holiday on the following Monday. Any holiday which falls on a Saturday shall be observed as a holiday on the preceding Friday.
- N. Holidays: New Year's Day, Memorial Day, Independence Day, Labor Day, Thanksgiving Day, the Friday after Thanksgiving Day, And Christmas Day (7). Any holiday which falls on a Sunday shall be observed as a holiday on the following Monday. When Christmas falls on a Saturday, the preceding Friday shall be observed as a holiday.
- P. Holidays: New Year's Day, Memorial Day, Independence Day, Labor Day, Thanksgiving Day, Friday after Thanksgiving Day, And Christmas Day (7). Any holiday which falls on a Sunday shall be observed as a holiday on the following Monday.
- Q. Holidays: New Year's Day, Memorial Day, Independence Day, Labor Day, Thanksgiving Day, the Friday after Thanksgiving Day, the Last Working Day before Christmas Day and Christmas Day (8). Any holiday which falls on a Sunday shall be observed as a holiday on the following Monday. If any of the listed holidays falls on a Saturday, the preceding Friday shall be a regular work day.
- S. Paid Holidays: New Year's Day, Memorial Day, Independence Day, Labor Day, Thanksgiving Day, Friday after Thanksgiving Day, Christmas Day, the Day after Christmas, and A Floating Holiday (9). If any of the listed holidays falls on a Sunday, the day observed by the Nation shall be considered a holiday and compensated accordingly.
- V. Holidays: New Year's Day, President's Birthday, Memorial Day, Independence Day, Labor Day, Thanksgiving Day, the Friday after Thanksgiving Day, Christmas Day, the day before or after Christmas, and the day before or after New Year's Day. If any of the above listed holidays falls on a Sunday, the day observed by the Nation shall be considered a holiday and compensated accordingly.
- W. Holidays: New Year's Day, Day After New Year's, Memorial Day, Independence Day, Labor Day, Thanksgiving Day, the Friday after Thanksgiving Day, Christmas Eve Day, Christmas Day, the day after Christmas, the day before New Year's Day, and a Floating Holiday.



**Holiday Codes Continued**

7. X. Holidays: New Year's Day, Day before or after New Year's Day, Presidents' Day, Memorial Day, Independence Day, Labor Day, Thanksgiving Day, the Friday after Thanksgiving Day, Christmas Day, and the day before or after Christmas day. If a holiday falls on a Saturday or on a Friday that is the normal day off, then the holiday will be taken on the last normal workday. If the holiday falls on a Monday that is the normal day off or on a Sunday, then the holiday will be taken on the next normal workday.
- Y. Holidays: New Year's Day, Presidents' Day, Memorial Day, Independence Day, Labor Day, Thanksgiving Day, the Friday after Thanksgiving Day, and Christmas Day. (8) If the holiday falls on a Sunday, then the day observed by the federal government shall be considered a holiday and compensated accordingly.
- G. New Year's Day, Washington's Birthday, Memorial Day, Independence Day, Labor Day, Thanksgiving Day, The Friday After Thanksgiving Day, the last scheduled workday before Christmas, and Christmas Day (9). If any of the listed holidays falls on a Sunday, the day observed by the Nation shall be considered a holiday and compensated accordingly.
- H. Holidays: New Year's Day, Martin Luther King Jr. Day, Independence Day, Memorial Day, Labor Day, Thanksgiving Day, the Friday after Thanksgiving Day, the Last Working Day before Christmas Day and Christmas Day (9). Any holiday which falls on a Sunday shall be observed as a holiday on the following Monday. Any holiday which falls on a Saturday shall be observed as a holiday on the preceding Friday.
- I. Holidays: New Year's Day, President's Day, Independence Day, Memorial Day, Labor Day, Thanksgiving Day, The Friday After Thanksgiving Day, The Day Before Christmas Day And Christmas Day (9). Any holiday which falls on a Sunday shall be observed as a holiday on the following Monday. Any holiday which falls on a Saturday shall be observed as a holiday on the preceding Friday.
- J. Holidays: New Year's Day, Independence Day, Memorial Day, Labor Day, Thanksgiving Day and Christmas Day (6). Any holiday which falls on a Sunday shall be observed as a holiday on the following Monday. Any holiday which falls on a Saturday shall be observed as a holiday on the preceding Friday.
- K. Holidays: New Year's Day, Memorial Day, Independence Day, Thanksgiving Day, the Friday and Saturday after Thanksgiving Day, And Christmas Day (8). Any holiday which falls on a Sunday shall be observed as a holiday on the following Monday. Any holiday which falls on a Saturday shall be observed as a holiday on the preceding Friday.
- L. Holidays: New Year's Day, Memorial Day, Labor Day, Independence Day, Thanksgiving Day, the Last Work Day before Christmas Day, And Christmas Day (7). Any holiday which falls on a Sunday shall be observed as a holiday on the following Monday. Any holiday which falls on a Saturday shall be observed as a holiday on the preceding Friday.
- N. Holidays: New Year's Day, Memorial Day, Independence Day, Labor Day, Thanksgiving Day, the Friday after Thanksgiving Day, And Christmas Day (7). Any holiday which falls on a Sunday shall be observed as a holiday on the following Monday. When Christmas falls on a Saturday, the preceding Friday shall be observed as a holiday.
- P. Holidays: New Year's Day, Memorial Day, Independence Day, Labor Day, Thanksgiving Day, Friday after Thanksgiving Day, And Christmas Day (7). Any holiday which falls on a Sunday shall be observed as a holiday on the following Monday.
- Q. Holidays: New Year's Day, Memorial Day, Independence Day, Labor Day, Thanksgiving Day, the Friday after Thanksgiving Day, the Last Working Day before Christmas Day and Christmas Day (8). Any holiday which falls on a Sunday shall be observed as a holiday on the following Monday. If any of the listed holidays falls on a Saturday, the preceding Friday shall be a regular work day.
- S. Paid Holidays: New Year's Day, Memorial Day, Independence Day, Labor Day, Thanksgiving Day, Friday after Thanksgiving Day, Christmas Day, the Day after Christmas, and A Floating Holiday (9). If any of the listed holidays falls on a Sunday, the day observed by the Nation shall be considered a holiday and compensated accordingly.

**Holiday Codes Continued**

7. V. Holidays: New Year's Day, President's Birthday, Memorial Day, Independence Day, Labor Day, Thanksgiving Day, the Friday after Thanksgiving Day, Christmas Day, the day before or after Christmas, and the day before or after New Year's Day. If any of the above listed holidays falls on a Sunday, the day observed by the Nation shall be considered a holiday and compensated accordingly.
- W. Holidays: New Year's Day, Day After New Year's, Memorial Day, Independence Day, Labor Day, Thanksgiving Day, the Friday after Thanksgiving Day, Christmas Eve Day, Christmas Day, the day after Christmas, the day before New Year's Day, and a Floating Holiday.
- X. Holidays: New Year's Day, Day before or after New Year's Day, Presidents' Day, Memorial Day, Independence Day, Labor Day, Thanksgiving Day, the Friday after Thanksgiving Day, Christmas Day, and the day before or after Christmas day. If a holiday falls on a Saturday or on a Friday that is the normal day off, then the holiday will be taken on the last normal workday. If the holiday falls on a Monday that is the normal day off or on a Sunday, then the holiday will be taken on the next normal workday.
- Y. Holidays: New Year's Day, Presidents' Day, Memorial Day, Independence Day, Labor Day, Thanksgiving Day, the Friday after Thanksgiving Day, and Christmas Day. (8) If the holiday falls on a Sunday, then the day observed by the federal government shall be considered a holiday and compensated accordingly.
- Z. Holidays: New Year's Day, Memorial Day, Independence Day, Labor Day, Thanksgiving Day, the Friday and Saturday after Thanksgiving Day, Christmas Eve, and Christmas Day (9). Any holiday which falls on a Saturday shall be observed as a holiday on the preceding Friday. Any holiday which falls on a Sunday shall be observed as a holiday on the following Monday.
15. G. New Year's Day, Washington's Birthday, Memorial Day, Independence Day, Labor Day, Thanksgiving Day, The Friday After Thanksgiving Day, the last scheduled workday before Christmas, and Christmas Day (9). If any of the listed holidays falls on a Sunday, the day observed by the Nation shall be considered a holiday and compensated accordingly.
- H. Holidays: New Year's Day, Memorial Day, Independence Day, Labor Day, Thanksgiving Day, Friday after Thanksgiving Day, Christmas Eve Day, and Christmas Day (8). When the following holidays fall on a Saturday (New Year's Day, Independence Day, and Christmas Day) the preceding Friday will be considered as the holiday; should they fall on a Sunday, the following Monday shall be considered as the holiday.
- I. Holidays: New Year's Day, President's Day, Memorial Day, Labor Day, Thanksgiving Day, the Friday after Thanksgiving Day, Christmas Day, the last regular workday before Christmas (8). Any holiday which falls on a Sunday shall be observed as a holiday on the following Monday.
- J. Holidays: New Year's Day, Martin Luther King Jr. Day, Memorial Day, Independence Day, Labor Day, Thanksgiving Day, the Friday and Saturday after Thanksgiving Day, and Christmas Day (9). Any holiday which falls on a Sunday shall be observed as a holiday on the following Monday. If any of the listed holidays falls on a Saturday, the preceding Friday shall be a regular work day.

**Note Codes**

8. D. Workers working with supplied air on hazmat projects receive an additional \$1.00 per hour.
- L. Workers on hazmat projects receive additional hourly premiums as follows -Level A: \$0.75, Level B: \$0.50, And Level C: \$0.25.
- M. Workers on hazmat projects receive additional hourly premiums as follows: Levels A & B: \$1.00, Levels C & D: \$0.50.
- N. Workers on hazmat projects receive additional hourly premiums as follows -Level A: \$1.00, Level B: \$0.75, Level C: \$0.50, And Level D: \$0.25.
- S. Effective August 31, 2012 – A Traffic Control Supervisor shall be present on the project whenever flagging or spotting or other traffic control labor is being utilized. Flaggers and Spotters shall be posted where shown on approved Traffic Control Plans or where directed by the Engineer. All flaggers and spotters shall possess a current flagging card issued by the State of Washington, Oregon, Montana, or Idaho. This classification is only effective on or after August 31, 2012.
- T. Effective August 31, 2012 – A Traffic Control Laborer performs the setup, maintenance and removal of all temporary traffic control devices and construction signs necessary to control vehicular, bicycle, and pedestrian traffic during construction operations. Flaggers and Spotters shall be posted where shown on approved Traffic Control Plans or where directed by the Engineer. All flaggers and spotters shall possess a current flagging card issued by the State of Washington, Oregon, Montana, or Idaho. This classification is only effective on or after August 31, 2012.
- U. Workers on hazmat projects receive additional hourly premiums as follows – Class A Suit: \$2.00, Class B Suit: \$1.50, And Class C Suit: \$1.00. Workers performing underground work receive an additional \$0.40 per hour for any and all work performed underground, including operating, servicing and repairing of equipment. The premium for underground work shall be paid for the entire shift worked. Workers who work suspended by a rope or cable receive an additional \$0.50 per hour. The premium for work suspended shall be paid for the entire shift worked. Workers who do “pioneer” work (break open a cut, build road, etc.) more than one hundred fifty (150) feet above grade elevation receive an additional \$0.50 per hour.
- V. In addition to the hourly wage and fringe benefits, the following depth and enclosure premiums shall be paid. The premiums are to be calculated for the maximum depth and distance into an enclosure that a diver reaches in a day. The premiums are to be paid one time for the day and are not used in calculating overtime pay.
- Depth premiums apply to depths of fifty feet or more. Over 50' to 100' - \$2.00 per foot for each foot over 50 feet. Over 101' to 150' - \$3.00 per foot for each foot over 101 feet. Over 151' to 220' - \$4.00 per foot for each foot over 220 feet. Over 221' - \$5.00 per foot for each foot over 221 feet.
- Enclosure premiums apply when divers enter enclosures (such as pipes or tunnels) where there is no vertical ascent and is measured by the distance travelled from the entrance. 25' to 300' - \$1.00 per foot from entrance. 300' to 600' - \$1.50 per foot beginning at 300'. Over 600' - \$2.00 per foot beginning at 600'.
- W. Meter Installers work on single phase 120/240V self-contained residential meters. The Lineman/Groundmen rates would apply to meters not fitting this description.

**Note Codes Continued**

8. X. Workers on hazmat projects receive additional hourly premiums as follows - Class A Suit: \$2.00, Class B Suit: \$1.50, Class C Suit: \$1.00, and Class D Suit: \$0.50. Special Shift Premium: Basic hourly rate plus \$2.00 per hour.

When due to conditions beyond the control of the Employer or when an owner (not acting as the contractor), a government agency or the contract specifications requires that work can only be performed outside the normal 5 am to 6pm shift, then the special shift premium will be applied to the basic hourly rate. When an employee works on a special shift, they shall be paid a special shift premium for each hour worked unless they are in OT or Double-time status. (For example, the special shift premium does not waive the overtime requirements for work performed on Saturday or Sunday.)

- Y. Tide Work: When employees are called out between the hours of 6:00 p.m. and 6:00 a.m. to work on tide work (work located in the tide plane) all time worked shall be at one and one-half times the hourly rate of pay.

Swinging Stage/Boatswains Chair: Employees working on a swinging state or boatswains chair or under conditions that require them to be tied off to allow their hands to be free shall receive seventy-five cents (\$0.75) per hour above the classification rate.

- Z. Workers working with supplied air on hazmat projects receive an additional \$1.00 per hour.

Special Shift Premium: Basic hourly rate plus \$2.00 per hour. When due to conditions beyond the control of the Employer or when an owner (not acting as a contractor), a government agency or the contract specifications require that more than (4) hours of a special shift can only be performed outside the normal 6 am to 6pm shift, then the special shift premium will be applied to the basic straight time for the entire shift. When an employee works on a special shift, they will be paid a special shift premium for each hour worked unless they are in overtime or double-time status. (For example, the special shift premium does not waive the overtime requirements for work performed on Saturday or Sunday.)

9. A. Workers working with supplied air on hazmat projects receive an additional \$1.00 per hour.

Special Shift Premium: Basic hourly rate plus \$2.00 per hour. When due to conditions beyond the control of the Employer or when an owner (not acting as the contractor), a government agency or the contract specifications require that more than four (4) hours of a special shift can only be performed outside the normal 6 am to 6pm shift, then the special shift premium will be applied to the basic straight time for the entire shift. When an employee works on a special shift, they shall be paid a special shift premium for each hour worked unless they are in overtime or double-time status. (For example, the special shift premium does not waive the overtime requirements for work performed on Saturday or Sunday.)

Certified Crane Operator Premium: Crane operators requiring certifications shall be paid \$0.50 per hour above their classification rate.

Boom Pay Premium: All cranes including tower shall be paid as follows based on boom length:

- (A) – 130’ to 199’ – \$0.50 per hour over their classification rate.
- (B) – 200’ to 299’ – \$0.80 per hour over their classification rate.
- (C) – 300’ and over – \$1.00 per hour over their classification rate.

**Note Codes Continued**

9. B. The highest pressure registered on the gauge for an accumulated time of more than fifteen (15) minutes during the shift shall be used in determining the scale paid.

Tide Work: When employees are called out between the hours of 6:00 p.m. and 6:00 a.m. to work on tide work (work located in the tide plane) all time worked shall be at one and one-half times the hourly rate of pay. Swinging Stage/Boatswains Chair: Employees working on a swinging stage or boatswains chair or under conditions that require them to be tied off to allow their hands to be free shall receive seventy-five cents (\$0.75) per hour above the classification rate.

- C. Tide Work: When employees are called out between the hours of 6:00 p.m. and 6:00 a.m. to work on tide work (work located in the tide plane) all time worked shall be at one and one-half times the hourly rate of pay. Swinging Stage/Boatswains Chair: Employees working on a swinging stage or boatswains chair or under conditions that require them to be tied off to allow their hands to be free shall receive seventy-five cents (\$0.75) per hour above the classification rate.

Effective August 31, 2012 – A Traffic Control Supervisor shall be present on the project whenever flagging or spotting or other traffic control labor is being utilized. A Traffic Control Laborer performs the setup, maintenance and removal of all temporary traffic control devices and construction signs necessary to control vehicular, bicycle, and pedestrian traffic during construction operations. Flaggers and Spotters shall be posted where shown on approved Traffic Control Plans or where directed by the Engineer. All flaggers and spotters shall possess a current flagging card issued by the State of Washington, Oregon, Montana, or Idaho. These classifications are only effective on or after August 31, 2012.

- D. Industrial Painter wages are required for painting within industrial facilities such as treatment plants, pipelines, towers, dams, bridges, power generation facilities and manufacturing facilities such as chemical plants, etc., or anywhere abrasive blasting is necessary to prepare surfaces, or hazardous materials encapsulation is required.
- E. Heavy Construction includes construction, repair, alteration or additions to the production, fabrication or manufacturing portions of industrial or manufacturing plants, hydroelectric or nuclear power plants and atomic reactor construction. Workers on hazmat projects receive additional hourly premiums as follows -Level A: \$1.00, Level B: \$0.75, Level C: \$0.50, And Level D: \$0.25.
- F. Industrial Painter wages are required for painting within industrial facilities such as treatment plants, pipelines, towers, dams, power generation facilities and manufacturing facilities such as chemical plants, etc., or anywhere abrasive blasting is necessary to prepare surfaces, or hazardous materials encapsulation is required.

State of Washington  
 Department of Labor & Industries  
 Prevailing Wage Section - Telephone 360-902-5335  
 PO Box 44540, Olympia, WA 98504-4540

**Washington State Prevailing Wage**

The PREVAILING WAGES listed here include both the hourly wage rate and the hourly rate of fringe benefits. On public works projects, worker's wage and benefit rates must add to not less than this total. A brief description of overtime calculation requirements are provided on the Benefit Code Key.

Journey Level Prevailing Wage Rates for the Effective Date: 1/13/2023

<u>County</u>	<u>Trade</u>	<u>Job Classification</u>	<u>Wage</u>	<u>Holiday</u>	<u>Overtime</u>	<u>Note</u>	<u>*Risk Class</u>
King	<a href="#">Asbestos Abatement Workers</a>	Journey Level	\$56.80	<a href="#">5D</a>	<a href="#">1H</a>		<a href="#">View</a>
King	<a href="#">Ironworkers</a>	Journeyman	\$82.03	<a href="#">7N</a>	<a href="#">1O</a>		<a href="#">View</a>
King	<a href="#">Laborers</a>	Air, Gas Or Electric Vibrating Screed	\$56.80	<a href="#">15J</a>	<a href="#">4V</a>	<a href="#">8Y</a>	<a href="#">View</a>
King	<a href="#">Laborers</a>	Airtrac Drill Operator	\$58.56	<a href="#">15J</a>	<a href="#">4V</a>	<a href="#">8Y</a>	<a href="#">View</a>
King	<a href="#">Laborers</a>	Ballast Regular Machine	\$56.80	<a href="#">15J</a>	<a href="#">4V</a>	<a href="#">8Y</a>	<a href="#">View</a>
King	<a href="#">Laborers</a>	Batch Weighman	\$48.14	<a href="#">15J</a>	<a href="#">4V</a>	<a href="#">8Y</a>	<a href="#">View</a>
King	<a href="#">Laborers</a>	Brick Pavers	\$56.80	<a href="#">15J</a>	<a href="#">4V</a>	<a href="#">8Y</a>	<a href="#">View</a>
King	<a href="#">Laborers</a>	Brush Cutter	\$56.80	<a href="#">15J</a>	<a href="#">4V</a>	<a href="#">8Y</a>	<a href="#">View</a>
King	<a href="#">Laborers</a>	Brush Hog Feeder	\$56.80	<a href="#">15J</a>	<a href="#">4V</a>	<a href="#">8Y</a>	<a href="#">View</a>
King	<a href="#">Laborers</a>	Burner	\$56.80	<a href="#">15J</a>	<a href="#">4V</a>	<a href="#">8Y</a>	<a href="#">View</a>
King	<a href="#">Laborers</a>	Caisson Worker	\$58.56	<a href="#">15J</a>	<a href="#">4V</a>	<a href="#">8Y</a>	<a href="#">View</a>
King	<a href="#">Laborers</a>	Carpenter Tender	\$56.80	<a href="#">15J</a>	<a href="#">4V</a>	<a href="#">8Y</a>	<a href="#">View</a>
King	<a href="#">Laborers</a>	Cement Dumper-paving	\$57.84	<a href="#">15J</a>	<a href="#">4V</a>	<a href="#">8Y</a>	<a href="#">View</a>
King	<a href="#">Laborers</a>	Cement Finisher Tender	\$56.80	<a href="#">15J</a>	<a href="#">4V</a>	<a href="#">8Y</a>	<a href="#">View</a>
King	<a href="#">Laborers</a>	Change House Or Dry Shack	\$56.80	<a href="#">15J</a>	<a href="#">4V</a>	<a href="#">8Y</a>	<a href="#">View</a>
King	<a href="#">Laborers</a>	Chipping Gun (30 Lbs. And Over)	\$57.84	<a href="#">15J</a>	<a href="#">4V</a>	<a href="#">8Y</a>	<a href="#">View</a>
King	<a href="#">Laborers</a>	Chipping Gun (Under 30 Lbs.)	\$56.80	<a href="#">15J</a>	<a href="#">4V</a>	<a href="#">8Y</a>	<a href="#">View</a>
King	<a href="#">Laborers</a>	Choker Setter	\$56.80	<a href="#">15J</a>	<a href="#">4V</a>	<a href="#">8Y</a>	<a href="#">View</a>
King	<a href="#">Laborers</a>	Chuck Tender	\$56.80	<a href="#">15J</a>	<a href="#">4V</a>	<a href="#">8Y</a>	<a href="#">View</a>
King	<a href="#">Laborers</a>	Clary Power Spreader	\$57.84	<a href="#">15J</a>	<a href="#">4V</a>	<a href="#">8Y</a>	<a href="#">View</a>
King	<a href="#">Laborers</a>	Clean-up Laborer	\$56.80	<a href="#">15J</a>	<a href="#">4V</a>	<a href="#">8Y</a>	<a href="#">View</a>
King	<a href="#">Laborers</a>	Concrete Dumper/Chute Operator	\$57.84	<a href="#">15J</a>	<a href="#">4V</a>	<a href="#">8Y</a>	<a href="#">View</a>
King	<a href="#">Laborers</a>	Concrete Form Stripper	\$56.80	<a href="#">15J</a>	<a href="#">4V</a>	<a href="#">8Y</a>	<a href="#">View</a>
King	<a href="#">Laborers</a>	Concrete Placement Crew	\$57.84	<a href="#">15J</a>	<a href="#">4V</a>	<a href="#">8Y</a>	<a href="#">View</a>
King	<a href="#">Laborers</a>	Concrete Saw Operator/Core Driller	\$57.84	<a href="#">15J</a>	<a href="#">4V</a>	<a href="#">8Y</a>	<a href="#">View</a>
King	<a href="#">Laborers</a>	Crusher Feeder	\$48.14	<a href="#">15J</a>	<a href="#">4V</a>	<a href="#">8Y</a>	<a href="#">View</a>
King	<a href="#">Laborers</a>	Curing Laborer	\$56.80	<a href="#">15J</a>	<a href="#">4V</a>	<a href="#">8Y</a>	<a href="#">View</a>

King	<a href="#">Laborers</a>	Demolition: Wrecking & Moving (Incl. Charred Material)	\$56.80	<a href="#">15J</a>	<a href="#">4V</a>	<a href="#">8Y</a>	<a href="#">View</a>
King	<a href="#">Laborers</a>	Ditch Digger	\$56.80	<a href="#">15J</a>	<a href="#">4V</a>	<a href="#">8Y</a>	<a href="#">View</a>
King	<a href="#">Laborers</a>	Diver	\$58.56	<a href="#">15J</a>	<a href="#">4V</a>	<a href="#">8Y</a>	<a href="#">View</a>
King	<a href="#">Laborers</a>	Drill Operator (Hydraulic, Diamond)	\$57.84	<a href="#">15J</a>	<a href="#">4V</a>	<a href="#">8Y</a>	<a href="#">View</a>
King	<a href="#">Laborers</a>	Dry Stack Walls	\$56.80	<a href="#">15J</a>	<a href="#">4V</a>	<a href="#">8Y</a>	<a href="#">View</a>
King	<a href="#">Laborers</a>	Dump Person	\$56.80	<a href="#">15J</a>	<a href="#">4V</a>	<a href="#">8Y</a>	<a href="#">View</a>
King	<a href="#">Laborers</a>	Epoxy Technician	\$56.80	<a href="#">15J</a>	<a href="#">4V</a>	<a href="#">8Y</a>	<a href="#">View</a>
King	<a href="#">Laborers</a>	Erosion Control Worker	\$56.80	<a href="#">15J</a>	<a href="#">4V</a>	<a href="#">8Y</a>	<a href="#">View</a>
King	<a href="#">Laborers</a>	Faller & Bucker Chain Saw	\$57.84	<a href="#">15J</a>	<a href="#">4V</a>	<a href="#">8Y</a>	<a href="#">View</a>
King	<a href="#">Laborers</a>	Fine Graders	\$56.80	<a href="#">15J</a>	<a href="#">4V</a>	<a href="#">8Y</a>	<a href="#">View</a>
King	<a href="#">Laborers</a>	Firewatch	\$48.14	<a href="#">15J</a>	<a href="#">4V</a>	<a href="#">8Y</a>	<a href="#">View</a>
King	<a href="#">Laborers</a>	Form Setter	\$57.84	<a href="#">15J</a>	<a href="#">4V</a>	<a href="#">8Y</a>	<a href="#">View</a>
King	<a href="#">Laborers</a>	Gabian Basket Builders	\$56.80	<a href="#">15J</a>	<a href="#">4V</a>	<a href="#">8Y</a>	<a href="#">View</a>
King	<a href="#">Laborers</a>	General Laborer	\$56.80	<a href="#">15J</a>	<a href="#">4V</a>	<a href="#">8Y</a>	<a href="#">View</a>
King	<a href="#">Laborers</a>	Grade Checker & Transit Person	\$59.85	<a href="#">15J</a>	<a href="#">4V</a>	<a href="#">8Y</a>	<a href="#">View</a>
King	<a href="#">Laborers</a>	Grinders	\$56.80	<a href="#">15J</a>	<a href="#">4V</a>	<a href="#">8Y</a>	<a href="#">View</a>
King	<a href="#">Laborers</a>	Grout Machine Tender	\$56.80	<a href="#">15J</a>	<a href="#">4V</a>	<a href="#">8Y</a>	<a href="#">View</a>
King	<a href="#">Laborers</a>	Groutmen (Pressure) Including Post Tension Beams	\$57.84	<a href="#">15J</a>	<a href="#">4V</a>	<a href="#">8Y</a>	<a href="#">View</a>
King	<a href="#">Laborers</a>	Guardrail Erector	\$56.80	<a href="#">15J</a>	<a href="#">4V</a>	<a href="#">8Y</a>	<a href="#">View</a>
King	<a href="#">Laborers</a>	Hazardous Waste Worker (Level A)	\$58.56	<a href="#">15J</a>	<a href="#">4V</a>	<a href="#">8Y</a>	<a href="#">View</a>
King	<a href="#">Laborers</a>	Hazardous Waste Worker (Level B)	\$57.84	<a href="#">15J</a>	<a href="#">4V</a>	<a href="#">8Y</a>	<a href="#">View</a>
King	<a href="#">Laborers</a>	Hazardous Waste Worker (Level C)	\$56.80	<a href="#">15J</a>	<a href="#">4V</a>	<a href="#">8Y</a>	<a href="#">View</a>
King	<a href="#">Laborers</a>	High Scaler	\$58.56	<a href="#">15J</a>	<a href="#">4V</a>	<a href="#">8Y</a>	<a href="#">View</a>
King	<a href="#">Laborers</a>	Jackhammer	\$57.84	<a href="#">15J</a>	<a href="#">4V</a>	<a href="#">8Y</a>	<a href="#">View</a>
King	<a href="#">Laborers</a>	Laserbeam Operator	\$57.84	<a href="#">15J</a>	<a href="#">4V</a>	<a href="#">8Y</a>	<a href="#">View</a>
King	<a href="#">Laborers</a>	Maintenance Person	\$56.80	<a href="#">15J</a>	<a href="#">4V</a>	<a href="#">8Y</a>	<a href="#">View</a>
King	<a href="#">Laborers</a>	Manhole Builder-Mudman	\$57.84	<a href="#">15J</a>	<a href="#">4V</a>	<a href="#">8Y</a>	<a href="#">View</a>
King	<a href="#">Laborers</a>	Material Yard Person	\$56.80	<a href="#">15J</a>	<a href="#">4V</a>	<a href="#">8Y</a>	<a href="#">View</a>
King	<a href="#">Laborers</a>	Mold Abatement Worker	\$56.80	<a href="#">15J</a>	<a href="#">4V</a>	<a href="#">8Y</a>	<a href="#">View</a>
King	<a href="#">Laborers</a>	Motorman-Dinky Locomotive	\$59.95	<a href="#">15J</a>	<a href="#">4V</a>	<a href="#">8Y</a>	<a href="#">View</a>
King	<a href="#">Laborers</a>	nozzleman (concrete pump, green cutter when using combination of high pressure air & water on concrete & rock, sandblast, gunite, shotcrete, water blaster, vacuum blaster)	\$59.85	<a href="#">15J</a>	<a href="#">4V</a>	<a href="#">8Y</a>	<a href="#">View</a>
King	<a href="#">Laborers</a>	Pavement Breaker	\$57.84	<a href="#">15J</a>	<a href="#">4V</a>	<a href="#">8Y</a>	<a href="#">View</a>
King	<a href="#">Laborers</a>	Pilot Car	\$48.14	<a href="#">15J</a>	<a href="#">4V</a>	<a href="#">8Y</a>	<a href="#">View</a>
King	<a href="#">Laborers</a>	Pipe Layer (Lead)	\$59.85	<a href="#">15J</a>	<a href="#">4V</a>	<a href="#">8Y</a>	<a href="#">View</a>
King	<a href="#">Laborers</a>	Pipe Layer/Tailor	\$57.84	<a href="#">15J</a>	<a href="#">4V</a>	<a href="#">8Y</a>	<a href="#">View</a>
King	<a href="#">Laborers</a>	Pipe Pot Tender	\$57.84	<a href="#">15J</a>	<a href="#">4V</a>	<a href="#">8Y</a>	<a href="#">View</a>
King	<a href="#">Laborers</a>	Pipe Reliner	\$57.84	<a href="#">15J</a>	<a href="#">4V</a>	<a href="#">8Y</a>	<a href="#">View</a>
King	<a href="#">Laborers</a>	Pipe Wrapper	\$57.84	<a href="#">15J</a>	<a href="#">4V</a>	<a href="#">8Y</a>	<a href="#">View</a>

King	<a href="#">Laborers</a>	Pot Tender	\$56.80	<a href="#">15J</a>	<a href="#">4V</a>	<a href="#">8Y</a>	<a href="#">View</a>
King	<a href="#">Laborers</a>	Powderman	\$58.56	<a href="#">15J</a>	<a href="#">4V</a>	<a href="#">8Y</a>	<a href="#">View</a>
King	<a href="#">Laborers</a>	Powderman's Helper	\$56.80	<a href="#">15J</a>	<a href="#">4V</a>	<a href="#">8Y</a>	<a href="#">View</a>
King	<a href="#">Laborers</a>	Power Jacks	\$57.84	<a href="#">15J</a>	<a href="#">4V</a>	<a href="#">8Y</a>	<a href="#">View</a>
King	<a href="#">Laborers</a>	Railroad Spike Puller - Power	\$57.84	<a href="#">15J</a>	<a href="#">4V</a>	<a href="#">8Y</a>	<a href="#">View</a>
King	<a href="#">Laborers</a>	Raker - Asphalt	\$59.85	<a href="#">15J</a>	<a href="#">4V</a>	<a href="#">8Y</a>	<a href="#">View</a>
King	<a href="#">Laborers</a>	Re-timberman	\$58.56	<a href="#">15J</a>	<a href="#">4V</a>	<a href="#">8Y</a>	<a href="#">View</a>
King	<a href="#">Laborers</a>	Remote Equipment Operator	\$57.84	<a href="#">15J</a>	<a href="#">4V</a>	<a href="#">8Y</a>	<a href="#">View</a>
King	<a href="#">Laborers</a>	Rigger/Signal Person	\$57.84	<a href="#">15J</a>	<a href="#">4V</a>	<a href="#">8Y</a>	<a href="#">View</a>
King	<a href="#">Laborers</a>	Rip Rap Person	\$56.80	<a href="#">15J</a>	<a href="#">4V</a>	<a href="#">8Y</a>	<a href="#">View</a>
King	<a href="#">Laborers</a>	Rivet Buster	\$57.84	<a href="#">15J</a>	<a href="#">4V</a>	<a href="#">8Y</a>	<a href="#">View</a>
King	<a href="#">Laborers</a>	Rodder	\$57.84	<a href="#">15J</a>	<a href="#">4V</a>	<a href="#">8Y</a>	<a href="#">View</a>
King	<a href="#">Laborers</a>	Scaffold Erector	\$56.80	<a href="#">15J</a>	<a href="#">4V</a>	<a href="#">8Y</a>	<a href="#">View</a>
King	<a href="#">Laborers</a>	Scale Person	\$56.80	<a href="#">15J</a>	<a href="#">4V</a>	<a href="#">8Y</a>	<a href="#">View</a>
King	<a href="#">Laborers</a>	Sloper (Over 20")	\$57.84	<a href="#">15J</a>	<a href="#">4V</a>	<a href="#">8Y</a>	<a href="#">View</a>
King	<a href="#">Laborers</a>	Sloper Sprayer	\$56.80	<a href="#">15J</a>	<a href="#">4V</a>	<a href="#">8Y</a>	<a href="#">View</a>
King	<a href="#">Laborers</a>	Spreader (Concrete)	\$57.84	<a href="#">15J</a>	<a href="#">4V</a>	<a href="#">8Y</a>	<a href="#">View</a>
King	<a href="#">Laborers</a>	Stake Hopper	\$56.80	<a href="#">15J</a>	<a href="#">4V</a>	<a href="#">8Y</a>	<a href="#">View</a>
King	<a href="#">Laborers</a>	Stock Piler	\$56.80	<a href="#">15J</a>	<a href="#">4V</a>	<a href="#">8Y</a>	<a href="#">View</a>
King	<a href="#">Laborers</a>	Swinging Stage/Boatswain Chair	\$48.14	<a href="#">15J</a>	<a href="#">4V</a>	<a href="#">8Y</a>	<a href="#">View</a>
King	<a href="#">Laborers</a>	Tamper & Similar Electric, Air & Gas Operated Tools	\$57.84	<a href="#">15J</a>	<a href="#">4V</a>	<a href="#">8Y</a>	<a href="#">View</a>
King	<a href="#">Laborers</a>	Tamper (Multiple & Self-propelled)	\$57.84	<a href="#">15J</a>	<a href="#">4V</a>	<a href="#">8Y</a>	<a href="#">View</a>
King	<a href="#">Laborers</a>	Timber Person - Sewer (Lagger, Shorer & Cribber)	\$57.84	<a href="#">15J</a>	<a href="#">4V</a>	<a href="#">8Y</a>	<a href="#">View</a>
King	<a href="#">Laborers</a>	Toolroom Person (at Jobsite)	\$56.80	<a href="#">15J</a>	<a href="#">4V</a>	<a href="#">8Y</a>	<a href="#">View</a>
King	<a href="#">Laborers</a>	Topper	\$56.80	<a href="#">15J</a>	<a href="#">4V</a>	<a href="#">8Y</a>	<a href="#">View</a>
King	<a href="#">Laborers</a>	Track Laborer	\$56.80	<a href="#">15J</a>	<a href="#">4V</a>	<a href="#">8Y</a>	<a href="#">View</a>
King	<a href="#">Laborers</a>	Track Liner (Power)	\$57.84	<a href="#">15J</a>	<a href="#">4V</a>	<a href="#">8Y</a>	<a href="#">View</a>
King	<a href="#">Laborers</a>	Traffic Control Laborer	\$51.48	<a href="#">15J</a>	<a href="#">4V</a>	<a href="#">9C</a>	<a href="#">View</a>
King	<a href="#">Laborers</a>	Traffic Control Supervisor	\$54.55	<a href="#">15J</a>	<a href="#">4V</a>	<a href="#">9C</a>	<a href="#">View</a>
King	<a href="#">Laborers</a>	Truck Spotter	\$56.80	<a href="#">15J</a>	<a href="#">4V</a>	<a href="#">8Y</a>	<a href="#">View</a>
King	<a href="#">Laborers</a>	Tugger Operator	\$57.84	<a href="#">15J</a>	<a href="#">4V</a>	<a href="#">8Y</a>	<a href="#">View</a>
King	<a href="#">Laborers</a>	Tunnel Work-Compressed Air Worker 0-30 psi	\$158.87	<a href="#">15J</a>	<a href="#">4V</a>	<a href="#">9B</a>	<a href="#">View</a>
King	<a href="#">Laborers</a>	Tunnel Work-Compressed Air Worker 30.01-44.00 psi	\$163.90	<a href="#">15J</a>	<a href="#">4V</a>	<a href="#">9B</a>	<a href="#">View</a>
King	<a href="#">Laborers</a>	Tunnel Work-Compressed Air Worker 44.01-54.00 psi	\$167.58	<a href="#">15J</a>	<a href="#">4V</a>	<a href="#">9B</a>	<a href="#">View</a>
King	<a href="#">Laborers</a>	Tunnel Work-Compressed Air Worker 54.01-60.00 psi	\$173.28	<a href="#">15J</a>	<a href="#">4V</a>	<a href="#">9B</a>	<a href="#">View</a>
King	<a href="#">Laborers</a>	Tunnel Work-Compressed Air Worker 60.01-64.00 psi	\$175.40	<a href="#">15J</a>	<a href="#">4V</a>	<a href="#">9B</a>	<a href="#">View</a>
King	<a href="#">Laborers</a>	Tunnel Work-Compressed Air Worker 64.01-68.00 psi	\$180.50	<a href="#">15J</a>	<a href="#">4V</a>	<a href="#">9B</a>	<a href="#">View</a>
King	<a href="#">Laborers</a>	Tunnel Work-Compressed Air Worker 68.01-70.00 psi	\$182.40	<a href="#">15J</a>	<a href="#">4V</a>	<a href="#">9B</a>	<a href="#">View</a>



King	<a href="#">Laborers</a>	Tunnel Work-Compressed Air Worker 70.01-72.00 psi	\$184.40	<a href="#">15J</a>	<a href="#">4V</a>	<a href="#">9B</a>	<a href="#">View</a>
King	<a href="#">Laborers</a>	Tunnel Work-Compressed Air Worker 72.01-74.00 psi	\$186.40	<a href="#">15J</a>	<a href="#">4V</a>	<a href="#">9B</a>	<a href="#">View</a>
King	<a href="#">Laborers</a>	Tunnel Work-Guage and Lock Tender	\$59.95	<a href="#">15J</a>	<a href="#">4V</a>	<a href="#">8Y</a>	<a href="#">View</a>
King	<a href="#">Laborers</a>	Tunnel Work-Miner	\$59.95	<a href="#">15J</a>	<a href="#">4V</a>	<a href="#">8Y</a>	<a href="#">View</a>
King	<a href="#">Laborers</a>	Vibrator	\$57.84	<a href="#">15J</a>	<a href="#">4V</a>	<a href="#">8Y</a>	<a href="#">View</a>
King	<a href="#">Laborers</a>	Vinyl Seamer	\$56.80	<a href="#">15J</a>	<a href="#">4V</a>	<a href="#">8Y</a>	<a href="#">View</a>
King	<a href="#">Laborers</a>	Watchman	\$43.76	<a href="#">15J</a>	<a href="#">4V</a>	<a href="#">8Y</a>	<a href="#">View</a>
King	<a href="#">Laborers</a>	Welder	\$57.84	<a href="#">15J</a>	<a href="#">4V</a>	<a href="#">8Y</a>	<a href="#">View</a>
King	<a href="#">Laborers</a>	Well Point Laborer	\$57.84	<a href="#">15J</a>	<a href="#">4V</a>	<a href="#">8Y</a>	<a href="#">View</a>
King	<a href="#">Laborers</a>	Window Washer/Cleaner	\$43.76	<a href="#">15J</a>	<a href="#">4V</a>	<a href="#">8Y</a>	<a href="#">View</a>
King	<a href="#">Laborers - Underground Sewer &amp; Water</a>	General Laborer & Topman	\$56.80	<a href="#">15J</a>	<a href="#">4V</a>	<a href="#">8Y</a>	<a href="#">View</a>
King	<a href="#">Laborers - Underground Sewer &amp; Water</a>	Pipe Layer	\$57.84	<a href="#">15J</a>	<a href="#">4V</a>	<a href="#">8Y</a>	<a href="#">View</a>
King	<a href="#">Plumbers &amp; Pipefitters</a>	Journey Level	\$95.69	<a href="#">6Z</a>	<a href="#">1G</a>		<a href="#">View</a>
King	<a href="#">Power Equipment Operators</a>	Asphalt Plant Operators	\$80.12	<a href="#">15J</a>	<a href="#">11G</a>	<a href="#">8X</a>	<a href="#">View</a>
King	<a href="#">Power Equipment Operators</a>	Assistant Engineer	\$75.35	<a href="#">15J</a>	<a href="#">11G</a>	<a href="#">8X</a>	<a href="#">View</a>
King	<a href="#">Power Equipment Operators</a>	Barrier Machine (zipper)	\$79.41	<a href="#">15J</a>	<a href="#">11G</a>	<a href="#">8X</a>	<a href="#">View</a>
King	<a href="#">Power Equipment Operators</a>	Batch Plant Operator: concrete	\$79.41	<a href="#">15J</a>	<a href="#">11G</a>	<a href="#">8X</a>	<a href="#">View</a>
King	<a href="#">Power Equipment Operators</a>	Boat Operator	\$80.33	<a href="#">7A</a>	<a href="#">11H</a>	<a href="#">8X</a>	<a href="#">View</a>
King	<a href="#">Power Equipment Operators</a>	Bobcat	\$75.35	<a href="#">15J</a>	<a href="#">11G</a>	<a href="#">8X</a>	<a href="#">View</a>
King	<a href="#">Power Equipment Operators</a>	Brokk - Remote Demolition Equipment	\$75.35	<a href="#">15J</a>	<a href="#">11G</a>	<a href="#">8X</a>	<a href="#">View</a>
King	<a href="#">Power Equipment Operators</a>	Brooms	\$75.35	<a href="#">15J</a>	<a href="#">11G</a>	<a href="#">8X</a>	<a href="#">View</a>
King	<a href="#">Power Equipment Operators</a>	Bump Cutter	\$79.41	<a href="#">15J</a>	<a href="#">11G</a>	<a href="#">8X</a>	<a href="#">View</a>
King	<a href="#">Power Equipment Operators</a>	Cableways	\$80.12	<a href="#">15J</a>	<a href="#">11G</a>	<a href="#">8X</a>	<a href="#">View</a>
King	<a href="#">Power Equipment Operators</a>	Chipper	\$79.41	<a href="#">15J</a>	<a href="#">11G</a>	<a href="#">8X</a>	<a href="#">View</a>
King	<a href="#">Power Equipment Operators</a>	Compressor	\$75.35	<a href="#">15J</a>	<a href="#">11G</a>	<a href="#">8X</a>	<a href="#">View</a>
King	<a href="#">Power Equipment Operators</a>	Concrete Finish Machine - Laser Screed	\$75.35	<a href="#">15J</a>	<a href="#">11G</a>	<a href="#">8X</a>	<a href="#">View</a>
King	<a href="#">Power Equipment Operators</a>	Concrete Pump - Mounted Or Trailer High Pressure Line Pump, Pump High Pressure	\$78.80	<a href="#">15J</a>	<a href="#">11G</a>	<a href="#">8X</a>	<a href="#">View</a>
King	<a href="#">Power Equipment Operators</a>	Concrete Pump: Truck Mount With Boom Attachment Over 42 M	\$80.12	<a href="#">15J</a>	<a href="#">11G</a>	<a href="#">8X</a>	<a href="#">View</a>
King	<a href="#">Power Equipment Operators</a>	Concrete Pump: Truck Mount With Boom Attachment Up To 42m	\$79.41	<a href="#">15J</a>	<a href="#">11G</a>	<a href="#">8X</a>	<a href="#">View</a>
King	<a href="#">Power Equipment Operators</a>	Conveyors	\$78.80	<a href="#">15J</a>	<a href="#">11G</a>	<a href="#">8X</a>	<a href="#">View</a>
King	<a href="#">Power Equipment Operators</a>	Cranes Friction: 200 tons and over	\$82.76	<a href="#">7A</a>	<a href="#">11H</a>	<a href="#">8X</a>	<a href="#">View</a>
King	<a href="#">Power Equipment Operators</a>	Cranes, A-frame: 10 tons and under	\$75.55	<a href="#">7A</a>	<a href="#">11H</a>	<a href="#">8X</a>	<a href="#">View</a>
King	<a href="#">Power Equipment Operators</a>	Cranes: 100 tons through 199 tons, or 150' of boom (including jib with attachments)	\$81.12	<a href="#">7A</a>	<a href="#">11H</a>	<a href="#">8X</a>	<a href="#">View</a>

King	<a href="#">Power Equipment Operators</a>	Cranes: 20 tons through 44 tons with attachments	\$79.62	<a href="#">7A</a>	<a href="#">11H</a>	<a href="#">8X</a>	<a href="#">View</a>
King	<a href="#">Power Equipment Operators</a>	Cranes: 200 tons- 299 tons, or 250' of boom including jib with attachments	\$81.97	<a href="#">7A</a>	<a href="#">11H</a>	<a href="#">8X</a>	<a href="#">View</a>
King	<a href="#">Power Equipment Operators</a>	Cranes: 300 tons and over or 300' of boom including jib with attachments	\$82.76	<a href="#">7A</a>	<a href="#">11H</a>	<a href="#">8X</a>	<a href="#">View</a>
King	<a href="#">Power Equipment Operators</a>	Cranes: 45 tons through 99 tons, under 150' of boom(including jib with attachments)	\$80.33	<a href="#">7A</a>	<a href="#">11H</a>	<a href="#">8X</a>	<a href="#">View</a>
King	<a href="#">Power Equipment Operators</a>	Cranes: Friction cranes through 199 tons	\$81.97	<a href="#">7A</a>	<a href="#">11H</a>	<a href="#">8X</a>	<a href="#">View</a>
King	<a href="#">Power Equipment Operators</a>	Cranes: through 19 tons with attachments, a-frame over 10 tons	\$79.00	<a href="#">7A</a>	<a href="#">11H</a>	<a href="#">8X</a>	<a href="#">View</a>
King	<a href="#">Power Equipment Operators</a>	Crusher	\$79.41	<a href="#">15J</a>	<a href="#">11G</a>	<a href="#">8X</a>	<a href="#">View</a>
King	<a href="#">Power Equipment Operators</a>	Deck Engineer/Deck Winches (power)	\$79.41	<a href="#">15J</a>	<a href="#">11G</a>	<a href="#">8X</a>	<a href="#">View</a>
King	<a href="#">Power Equipment Operators</a>	Derricks, On Building Work	\$80.12	<a href="#">15J</a>	<a href="#">11G</a>	<a href="#">8X</a>	<a href="#">View</a>
King	<a href="#">Power Equipment Operators</a>	Dozers D-9 & Under	\$78.80	<a href="#">15J</a>	<a href="#">11G</a>	<a href="#">8X</a>	<a href="#">View</a>
King	<a href="#">Power Equipment Operators</a>	Drill Oilers: Auger Type, Truck Or Crane Mount	\$78.80	<a href="#">15J</a>	<a href="#">11G</a>	<a href="#">8X</a>	<a href="#">View</a>
King	<a href="#">Power Equipment Operators</a>	Drilling Machine	\$80.92	<a href="#">15J</a>	<a href="#">11G</a>	<a href="#">8X</a>	<a href="#">View</a>
King	<a href="#">Power Equipment Operators</a>	Elevator and man-lift: permanent and shaft type	\$75.35	<a href="#">15J</a>	<a href="#">11G</a>	<a href="#">8X</a>	<a href="#">View</a>
King	<a href="#">Power Equipment Operators</a>	Finishing Machine, Bidwell And Gamaco & Similar Equipment	\$79.41	<a href="#">15J</a>	<a href="#">11G</a>	<a href="#">8X</a>	<a href="#">View</a>
King	<a href="#">Power Equipment Operators</a>	Forklift: 3000 lbs and over with attachments	\$78.80	<a href="#">15J</a>	<a href="#">11G</a>	<a href="#">8X</a>	<a href="#">View</a>
King	<a href="#">Power Equipment Operators</a>	Forklifts: under 3000 lbs. with attachments	\$75.35	<a href="#">15J</a>	<a href="#">11G</a>	<a href="#">8X</a>	<a href="#">View</a>
King	<a href="#">Power Equipment Operators</a>	Grade Engineer: Using Blue Prints, Cut Sheets, Etc	\$79.41	<a href="#">15J</a>	<a href="#">11G</a>	<a href="#">8X</a>	<a href="#">View</a>
King	<a href="#">Power Equipment Operators</a>	Gradechecker/Stakeman	\$75.35	<a href="#">15J</a>	<a href="#">11G</a>	<a href="#">8X</a>	<a href="#">View</a>
King	<a href="#">Power Equipment Operators</a>	Guardrail Punch	\$79.41	<a href="#">15J</a>	<a href="#">11G</a>	<a href="#">8X</a>	<a href="#">View</a>
King	<a href="#">Power Equipment Operators</a>	Hard Tail End Dump Articulating Off- Road Equipment 45 Yards. & Over	\$80.12	<a href="#">15J</a>	<a href="#">11G</a>	<a href="#">8X</a>	<a href="#">View</a>
King	<a href="#">Power Equipment Operators</a>	Hard Tail End Dump Articulating Off-road Equipment Under 45 Yards	\$79.41	<a href="#">15J</a>	<a href="#">11G</a>	<a href="#">8X</a>	<a href="#">View</a>
King	<a href="#">Power Equipment Operators</a>	Horizontal/Directional Drill Locator	\$78.80	<a href="#">15J</a>	<a href="#">11G</a>	<a href="#">8X</a>	<a href="#">View</a>
King	<a href="#">Power Equipment Operators</a>	Horizontal/Directional Drill Operator	\$79.41	<a href="#">15J</a>	<a href="#">11G</a>	<a href="#">8X</a>	<a href="#">View</a>
King	<a href="#">Power Equipment Operators</a>	Hydralifts/Boom Trucks Over 10 Tons	\$79.00	<a href="#">7A</a>	<a href="#">11H</a>	<a href="#">8X</a>	<a href="#">View</a>
King	<a href="#">Power Equipment Operators</a>	Hydralifts/boom trucks: 10 tons and under	\$75.55	<a href="#">7A</a>	<a href="#">11H</a>	<a href="#">8X</a>	<a href="#">View</a>
King	<a href="#">Power Equipment Operators</a>	Leverman	\$81.75	<a href="#">15J</a>	<a href="#">11G</a>	<a href="#">8X</a>	<a href="#">View</a>

King	<a href="#">Power Equipment Operators</a>	Loader, Overhead, 6 Yards. But Not Including 8 Yards	\$80.12	<a href="#">15J</a>	<a href="#">11G</a>	<a href="#">8X</a>	<a href="#">View</a>
King	<a href="#">Power Equipment Operators</a>	Loaders, Overhead Under 6 Yards	\$79.41	<a href="#">15J</a>	<a href="#">11G</a>	<a href="#">8X</a>	<a href="#">View</a>
King	<a href="#">Power Equipment Operators</a>	Loaders, Plant Feed	\$79.41	<a href="#">15J</a>	<a href="#">11G</a>	<a href="#">8X</a>	<a href="#">View</a>
King	<a href="#">Power Equipment Operators</a>	Loaders: Elevating Type Belt	\$78.80	<a href="#">15J</a>	<a href="#">11G</a>	<a href="#">8X</a>	<a href="#">View</a>
King	<a href="#">Power Equipment Operators</a>	Locomotives, All	\$79.41	<a href="#">15J</a>	<a href="#">11G</a>	<a href="#">8X</a>	<a href="#">View</a>
King	<a href="#">Power Equipment Operators</a>	Material Transfer Device	\$79.41	<a href="#">15J</a>	<a href="#">11G</a>	<a href="#">8X</a>	<a href="#">View</a>
King	<a href="#">Power Equipment Operators</a>	Mechanics: All (Leadmen - \$0.50 per hour over mechanic)	\$80.92	<a href="#">15J</a>	<a href="#">11G</a>	<a href="#">8X</a>	<a href="#">View</a>
King	<a href="#">Power Equipment Operators</a>	Motor Patrol Graders	\$80.12	<a href="#">15J</a>	<a href="#">11G</a>	<a href="#">8X</a>	<a href="#">View</a>
King	<a href="#">Power Equipment Operators</a>	Mucking Machine, Mole, Tunnel Drill, Boring, Road Header And/or Shield	\$80.12	<a href="#">15J</a>	<a href="#">11G</a>	<a href="#">8X</a>	<a href="#">View</a>
King	<a href="#">Power Equipment Operators</a>	Oil Distributors, Blower Distribution & Mulch Seeding Operator	\$75.35	<a href="#">15J</a>	<a href="#">11G</a>	<a href="#">8X</a>	<a href="#">View</a>
King	<a href="#">Power Equipment Operators</a>	Outside Hoists (Elevators and Manlifts), Air Tuggers, Strato	\$78.80	<a href="#">15J</a>	<a href="#">11G</a>	<a href="#">8X</a>	<a href="#">View</a>
King	<a href="#">Power Equipment Operators</a>	Overhead, bridge type Crane: 20 tons through 44 tons	\$79.62	<a href="#">7A</a>	<a href="#">11H</a>	<a href="#">8X</a>	<a href="#">View</a>
King	<a href="#">Power Equipment Operators</a>	Overhead, bridge type: 100 tons and over	\$81.12	<a href="#">7A</a>	<a href="#">11H</a>	<a href="#">8X</a>	<a href="#">View</a>
King	<a href="#">Power Equipment Operators</a>	Overhead, bridge type: 45 tons through 99 tons	\$80.33	<a href="#">7A</a>	<a href="#">11H</a>	<a href="#">8X</a>	<a href="#">View</a>
King	<a href="#">Power Equipment Operators</a>	Pavement Breaker	\$75.35	<a href="#">15J</a>	<a href="#">11G</a>	<a href="#">8X</a>	<a href="#">View</a>
King	<a href="#">Power Equipment Operators</a>	Pile Driver (other Than Crane Mount)	\$79.41	<a href="#">15J</a>	<a href="#">11G</a>	<a href="#">8X</a>	<a href="#">View</a>
King	<a href="#">Power Equipment Operators</a>	Plant Oiler - Asphalt, Crusher	\$78.80	<a href="#">15J</a>	<a href="#">11G</a>	<a href="#">8X</a>	<a href="#">View</a>
King	<a href="#">Power Equipment Operators</a>	Posthole Digger, Mechanical	\$75.35	<a href="#">15J</a>	<a href="#">11G</a>	<a href="#">8X</a>	<a href="#">View</a>
King	<a href="#">Power Equipment Operators</a>	Power Plant	\$75.35	<a href="#">15J</a>	<a href="#">11G</a>	<a href="#">8X</a>	<a href="#">View</a>
King	<a href="#">Power Equipment Operators</a>	Pumps - Water	\$75.35	<a href="#">15J</a>	<a href="#">11G</a>	<a href="#">8X</a>	<a href="#">View</a>
King	<a href="#">Power Equipment Operators</a>	Quad 9, Hd 41, D10 And Over	\$80.12	<a href="#">15J</a>	<a href="#">11G</a>	<a href="#">8X</a>	<a href="#">View</a>
King	<a href="#">Power Equipment Operators</a>	Quick Tower: no cab, under 100 feet in height base to boom	\$79.41	<a href="#">15J</a>	<a href="#">11G</a>	<a href="#">8X</a>	<a href="#">View</a>
King	<a href="#">Power Equipment Operators</a>	Remote Control Operator On Rubber Tired Earth Moving Equipment	\$80.12	<a href="#">15J</a>	<a href="#">11G</a>	<a href="#">8X</a>	<a href="#">View</a>
King	<a href="#">Power Equipment Operators</a>	Rigger and Bellman	\$75.55	<a href="#">7A</a>	<a href="#">11H</a>	<a href="#">8X</a>	<a href="#">View</a>
King	<a href="#">Power Equipment Operators</a>	Rigger/Signal Person, Bellman(Certified)	\$79.00	<a href="#">7A</a>	<a href="#">11H</a>	<a href="#">8X</a>	<a href="#">View</a>
King	<a href="#">Power Equipment Operators</a>	Rollagon	\$80.12	<a href="#">15J</a>	<a href="#">11G</a>	<a href="#">8X</a>	<a href="#">View</a>
King	<a href="#">Power Equipment Operators</a>	Roller, Other Than Plant Mix	\$75.35	<a href="#">15J</a>	<a href="#">11G</a>	<a href="#">8X</a>	<a href="#">View</a>
King	<a href="#">Power Equipment Operators</a>	Roller, Plant Mix Or Multi-lift Materials	\$78.80	<a href="#">15J</a>	<a href="#">11G</a>	<a href="#">8X</a>	<a href="#">View</a>
King	<a href="#">Power Equipment Operators</a>	Roto-mill, Roto-grinder	\$79.41	<a href="#">15J</a>	<a href="#">11G</a>	<a href="#">8X</a>	<a href="#">View</a>
King	<a href="#">Power Equipment Operators</a>	Saws - Concrete	\$78.80	<a href="#">15J</a>	<a href="#">11G</a>	<a href="#">8X</a>	<a href="#">View</a>
King	<a href="#">Power Equipment Operators</a>	Scraper, Self Propelled Under 45 Yards	\$79.41	<a href="#">15J</a>	<a href="#">11G</a>	<a href="#">8X</a>	<a href="#">View</a>
King	<a href="#">Power Equipment Operators</a>	Scrapers - Concrete & Carry All	\$78.80	<a href="#">15J</a>	<a href="#">11G</a>	<a href="#">8X</a>	<a href="#">View</a>

King	<a href="#">Power Equipment Operators</a>	Scrapers, Self-propelled: 45 Yards And Over	\$80.12	<a href="#">15J</a>	<a href="#">11G</a>	<a href="#">8X</a>	<a href="#">View</a>
King	<a href="#">Power Equipment Operators</a>	Service Engineers: Equipment	\$78.80	<a href="#">15J</a>	<a href="#">11G</a>	<a href="#">8X</a>	<a href="#">View</a>
King	<a href="#">Power Equipment Operators</a>	Shotcrete/Gunite Equipment	\$75.35	<a href="#">15J</a>	<a href="#">11G</a>	<a href="#">8X</a>	<a href="#">View</a>
King	<a href="#">Power Equipment Operators</a>	Shovel, Excavator, Backhoe, Tractors Under 15 Metric Tons	\$78.80	<a href="#">15J</a>	<a href="#">11G</a>	<a href="#">8X</a>	<a href="#">View</a>
King	<a href="#">Power Equipment Operators</a>	Shovel, Excavator, Backhoe: Over 30 Metric Tons To 50 Metric Tons	\$80.12	<a href="#">15J</a>	<a href="#">11G</a>	<a href="#">8X</a>	<a href="#">View</a>
King	<a href="#">Power Equipment Operators</a>	Shovel, Excavator, Backhoes, Tractors: 15 To 30 Metric Tons	\$79.41	<a href="#">15J</a>	<a href="#">11G</a>	<a href="#">8X</a>	<a href="#">View</a>
King	<a href="#">Power Equipment Operators</a>	Shovel, Excavator, Backhoes: Over 50 Metric Tons To 90 Metric Tons	\$80.92	<a href="#">15J</a>	<a href="#">11G</a>	<a href="#">8X</a>	<a href="#">View</a>
King	<a href="#">Power Equipment Operators</a>	Shovel, Excavator, Backhoes: Over 90 Metric Tons	\$81.75	<a href="#">15J</a>	<a href="#">11G</a>	<a href="#">8X</a>	<a href="#">View</a>
King	<a href="#">Power Equipment Operators</a>	Slipform Pavers	\$80.12	<a href="#">15J</a>	<a href="#">11G</a>	<a href="#">8X</a>	<a href="#">View</a>
King	<a href="#">Power Equipment Operators</a>	Spreader, Toppers & Screedman	\$80.12	<a href="#">15J</a>	<a href="#">11G</a>	<a href="#">8X</a>	<a href="#">View</a>
King	<a href="#">Power Equipment Operators</a>	Subgrader Trimmer	\$79.41	<a href="#">15J</a>	<a href="#">11G</a>	<a href="#">8X</a>	<a href="#">View</a>
King	<a href="#">Power Equipment Operators</a>	Tower Bucket Elevators	\$78.80	<a href="#">15J</a>	<a href="#">11G</a>	<a href="#">8X</a>	<a href="#">View</a>
King	<a href="#">Power Equipment Operators</a>	Tower Crane: over 175' through 250' in height, base to boom	\$81.97	<a href="#">7A</a>	<a href="#">11H</a>	<a href="#">8X</a>	<a href="#">View</a>
King	<a href="#">Power Equipment Operators</a>	Tower crane: up to 175' in height base to boom	\$81.12	<a href="#">7A</a>	<a href="#">11H</a>	<a href="#">8X</a>	<a href="#">View</a>
King	<a href="#">Power Equipment Operators</a>	Tower Cranes: over 250' in height from base to boom	\$82.76	<a href="#">7A</a>	<a href="#">11H</a>	<a href="#">8X</a>	<a href="#">View</a>
King	<a href="#">Power Equipment Operators</a>	Transporters, All Track Or Truck Type	\$80.12	<a href="#">15J</a>	<a href="#">11G</a>	<a href="#">8X</a>	<a href="#">View</a>
King	<a href="#">Power Equipment Operators</a>	Trenching Machines	\$78.80	<a href="#">15J</a>	<a href="#">11G</a>	<a href="#">8X</a>	<a href="#">View</a>
King	<a href="#">Power Equipment Operators</a>	Truck Crane Oiler/Driver: 100 tons and over	\$79.62	<a href="#">7A</a>	<a href="#">11H</a>	<a href="#">8X</a>	<a href="#">View</a>
King	<a href="#">Power Equipment Operators</a>	Truck crane oiler/driver: under 100 tons	\$79.00	<a href="#">7A</a>	<a href="#">11H</a>	<a href="#">8X</a>	<a href="#">View</a>
King	<a href="#">Power Equipment Operators</a>	Truck Mount Portable Conveyor	\$79.41	<a href="#">15J</a>	<a href="#">11G</a>	<a href="#">8X</a>	<a href="#">View</a>
King	<a href="#">Power Equipment Operators</a>	Vac Truck (Vactor Guzzler, Hydro Excavator)	\$79.41	<a href="#">15J</a>	<a href="#">11G</a>	<a href="#">8X</a>	<a href="#">View</a>
King	<a href="#">Power Equipment Operators</a>	Welder	\$80.12	<a href="#">15J</a>	<a href="#">11G</a>	<a href="#">8X</a>	<a href="#">View</a>
King	<a href="#">Power Equipment Operators</a>	Wheel Tractors, Farmall Type	\$75.35	<a href="#">15J</a>	<a href="#">11G</a>	<a href="#">8X</a>	<a href="#">View</a>
King	<a href="#">Power Equipment Operators</a>	Yo Yo Pay Dozer	\$79.41	<a href="#">15J</a>	<a href="#">11G</a>	<a href="#">8X</a>	<a href="#">View</a>
King	<a href="#">Power Equipment Operators-Underground Sewer &amp; Water</a>	Asphalt Plant Operators	\$80.12	<a href="#">15J</a>	<a href="#">11G</a>	<a href="#">8X</a>	<a href="#">View</a>
King	<a href="#">Power Equipment Operators-Underground Sewer &amp; Water</a>	Assistant Engineer	\$75.35	<a href="#">15J</a>	<a href="#">11G</a>	<a href="#">8X</a>	<a href="#">View</a>
King	<a href="#">Power Equipment Operators-Underground Sewer &amp; Water</a>	Barrier Machine (zipper)	\$79.41	<a href="#">15J</a>	<a href="#">11G</a>	<a href="#">8X</a>	<a href="#">View</a>
King	<a href="#">Power Equipment Operators-Underground Sewer &amp; Water</a>	Batch Plant Operator, Concrete	\$79.41	<a href="#">15J</a>	<a href="#">11G</a>	<a href="#">8X</a>	<a href="#">View</a>
King	<a href="#">Power Equipment Operators-Underground Sewer &amp; Water</a>	Boat Operator	\$80.33	<a href="#">7A</a>	<a href="#">11H</a>	<a href="#">8X</a>	<a href="#">View</a>
King	<a href="#">Power Equipment Operators-</a>	Bobcat	\$75.35	<a href="#">15J</a>	<a href="#">11G</a>	<a href="#">8X</a>	<a href="#">View</a>

	<a href="#">Underground Sewer &amp; Water</a>						
King	<a href="#">Power Equipment Operators-Underground Sewer &amp; Water</a>	Brokk - Remote Demolition Equipment	\$75.35	<a href="#">15J</a>	<a href="#">11G</a>	<a href="#">8X</a>	<a href="#">View</a>
King	<a href="#">Power Equipment Operators-Underground Sewer &amp; Water</a>	Brooms	\$75.35	<a href="#">15J</a>	<a href="#">11G</a>	<a href="#">8X</a>	<a href="#">View</a>
King	<a href="#">Power Equipment Operators-Underground Sewer &amp; Water</a>	Bump Cutter	\$79.41	<a href="#">15J</a>	<a href="#">11G</a>	<a href="#">8X</a>	<a href="#">View</a>
King	<a href="#">Power Equipment Operators-Underground Sewer &amp; Water</a>	Cableways	\$80.12	<a href="#">15J</a>	<a href="#">11G</a>	<a href="#">8X</a>	<a href="#">View</a>
King	<a href="#">Power Equipment Operators-Underground Sewer &amp; Water</a>	Chipper	\$79.41	<a href="#">15J</a>	<a href="#">11G</a>	<a href="#">8X</a>	<a href="#">View</a>
King	<a href="#">Power Equipment Operators-Underground Sewer &amp; Water</a>	Compressor	\$75.35	<a href="#">15J</a>	<a href="#">11G</a>	<a href="#">8X</a>	<a href="#">View</a>
King	<a href="#">Power Equipment Operators-Underground Sewer &amp; Water</a>	Concrete Finish Machine - Laser Screed	\$75.35	<a href="#">15J</a>	<a href="#">11G</a>	<a href="#">8X</a>	<a href="#">View</a>
King	<a href="#">Power Equipment Operators-Underground Sewer &amp; Water</a>	Concrete Pump - Mounted Or Trailer High Pressure Line Pump, Pump High Pressure	\$78.80	<a href="#">15J</a>	<a href="#">11G</a>	<a href="#">8X</a>	<a href="#">View</a>
King	<a href="#">Power Equipment Operators-Underground Sewer &amp; Water</a>	Concrete Pump: Truck Mount With Boom Attachment Over 42 M	\$80.12	<a href="#">15J</a>	<a href="#">11G</a>	<a href="#">8X</a>	<a href="#">View</a>
King	<a href="#">Power Equipment Operators-Underground Sewer &amp; Water</a>	Concrete Pump: Truck Mount With Boom Attachment Up To 42m	\$79.41	<a href="#">15J</a>	<a href="#">11G</a>	<a href="#">8X</a>	<a href="#">View</a>
King	<a href="#">Power Equipment Operators-Underground Sewer &amp; Water</a>	Conveyors	\$78.80	<a href="#">15J</a>	<a href="#">11G</a>	<a href="#">8X</a>	<a href="#">View</a>
King	<a href="#">Power Equipment Operators-Underground Sewer &amp; Water</a>	Cranes Friction: 200 tons and over	\$82.76	<a href="#">7A</a>	<a href="#">11H</a>	<a href="#">8X</a>	<a href="#">View</a>
King	<a href="#">Power Equipment Operators-Underground Sewer &amp; Water</a>	Cranes, A-frame: 10 tons and under	\$75.55	<a href="#">7A</a>	<a href="#">11H</a>	<a href="#">8X</a>	<a href="#">View</a>
King	<a href="#">Power Equipment Operators-Underground Sewer &amp; Water</a>	Cranes: 100 tons through 199 tons, or 150' of boom (including jib with attachments)	\$81.12	<a href="#">7A</a>	<a href="#">11H</a>	<a href="#">8X</a>	<a href="#">View</a>
King	<a href="#">Power Equipment Operators-Underground Sewer &amp; Water</a>	Cranes: 20 tons through 44 tons with attachments	\$79.62	<a href="#">7A</a>	<a href="#">11H</a>	<a href="#">8X</a>	<a href="#">View</a>
King	<a href="#">Power Equipment Operators-Underground Sewer &amp; Water</a>	Cranes: 20 tons through 44 tons with attachments	\$79.62	<a href="#">7A</a>	<a href="#">11H</a>	<a href="#">8X</a>	<a href="#">View</a>
King	<a href="#">Power Equipment Operators-Underground Sewer &amp; Water</a>	Cranes: 200 tons- 299 tons, or 250' of boom including jib with attachments	\$81.97	<a href="#">7A</a>	<a href="#">11H</a>	<a href="#">8X</a>	<a href="#">View</a>
King	<a href="#">Power Equipment Operators-Underground Sewer &amp; Water</a>	Cranes: 300 tons and over or 300' of boom including jib with attachments	\$82.76	<a href="#">7A</a>	<a href="#">11H</a>	<a href="#">8X</a>	<a href="#">View</a>
King	<a href="#">Power Equipment Operators-Underground Sewer &amp; Water</a>	Cranes: 45 tons through 99 tons, under 150' of boom(including jib with attachments)	\$80.33	<a href="#">7A</a>	<a href="#">11H</a>	<a href="#">8X</a>	<a href="#">View</a>
King	<a href="#">Power Equipment Operators-Underground Sewer &amp; Water</a>	Cranes: Friction cranes through 199 tons	\$81.97	<a href="#">7A</a>	<a href="#">11H</a>	<a href="#">8X</a>	<a href="#">View</a>
King	<a href="#">Power Equipment Operators-Underground Sewer &amp; Water</a>	Cranes: through 19 tons with attachments, a-frame over 10 tons	\$79.00	<a href="#">7A</a>	<a href="#">11H</a>	<a href="#">8X</a>	<a href="#">View</a>
King	<a href="#">Power Equipment Operators-Underground Sewer &amp; Water</a>	Crusher	\$79.41	<a href="#">15J</a>	<a href="#">11G</a>	<a href="#">8X</a>	<a href="#">View</a>

King	<a href="#">Power Equipment Operators-Underground Sewer &amp; Water</a>	Deck Engineer/Deck Winches (power)	\$79.41	<a href="#">15J</a>	<a href="#">11G</a>	<a href="#">8X</a>	<a href="#">View</a>
King	<a href="#">Power Equipment Operators-Underground Sewer &amp; Water</a>	Derricks, On Building Work	\$80.12	<a href="#">15J</a>	<a href="#">11G</a>	<a href="#">8X</a>	<a href="#">View</a>
King	<a href="#">Power Equipment Operators-Underground Sewer &amp; Water</a>	Dozers D-9 & Under	\$78.80	<a href="#">15J</a>	<a href="#">11G</a>	<a href="#">8X</a>	<a href="#">View</a>
King	<a href="#">Power Equipment Operators-Underground Sewer &amp; Water</a>	Drill Oilers: Auger Type, Truck Or Crane Mount	\$78.80	<a href="#">15J</a>	<a href="#">11G</a>	<a href="#">8X</a>	<a href="#">View</a>
King	<a href="#">Power Equipment Operators-Underground Sewer &amp; Water</a>	Drilling Machine	\$80.92	<a href="#">15J</a>	<a href="#">11G</a>	<a href="#">8X</a>	<a href="#">View</a>
King	<a href="#">Power Equipment Operators-Underground Sewer &amp; Water</a>	Elevator and man-lift: permanent and shaft type	\$75.35	<a href="#">15J</a>	<a href="#">11G</a>	<a href="#">8X</a>	<a href="#">View</a>
King	<a href="#">Power Equipment Operators-Underground Sewer &amp; Water</a>	Finishing Machine, Bidwell And Gamaco & Similar Equipment	\$79.41	<a href="#">15J</a>	<a href="#">11G</a>	<a href="#">8X</a>	<a href="#">View</a>
King	<a href="#">Power Equipment Operators-Underground Sewer &amp; Water</a>	Forklift: 3000 lbs and over with attachments	\$78.80	<a href="#">15J</a>	<a href="#">11G</a>	<a href="#">8X</a>	<a href="#">View</a>
King	<a href="#">Power Equipment Operators-Underground Sewer &amp; Water</a>	Forklifts: under 3000 lbs. with attachments	\$75.35	<a href="#">15J</a>	<a href="#">11G</a>	<a href="#">8X</a>	<a href="#">View</a>
King	<a href="#">Power Equipment Operators-Underground Sewer &amp; Water</a>	Grade Engineer: Using Blue Prints, Cut Sheets, Etc	\$79.41	<a href="#">15J</a>	<a href="#">11G</a>	<a href="#">8X</a>	<a href="#">View</a>
King	<a href="#">Power Equipment Operators-Underground Sewer &amp; Water</a>	Gradechecker/Stakeman	\$75.35	<a href="#">15J</a>	<a href="#">11G</a>	<a href="#">8X</a>	<a href="#">View</a>
King	<a href="#">Power Equipment Operators-Underground Sewer &amp; Water</a>	Guardrail Punch	\$79.41	<a href="#">15J</a>	<a href="#">11G</a>	<a href="#">8X</a>	<a href="#">View</a>
King	<a href="#">Power Equipment Operators-Underground Sewer &amp; Water</a>	Hard Tail End Dump Articulating Off- Road Equipment 45 Yards. & Over	\$80.12	<a href="#">15J</a>	<a href="#">11G</a>	<a href="#">8X</a>	<a href="#">View</a>
King	<a href="#">Power Equipment Operators-Underground Sewer &amp; Water</a>	Hard Tail End Dump Articulating Off-road Equipment Under 45 Yards	\$79.41	<a href="#">15J</a>	<a href="#">11G</a>	<a href="#">8X</a>	<a href="#">View</a>
King	<a href="#">Power Equipment Operators-Underground Sewer &amp; Water</a>	Horizontal/Directional Drill Locator	\$78.80	<a href="#">15J</a>	<a href="#">11G</a>	<a href="#">8X</a>	<a href="#">View</a>
King	<a href="#">Power Equipment Operators-Underground Sewer &amp; Water</a>	Horizontal/Directional Drill Operator	\$79.41	<a href="#">15J</a>	<a href="#">11G</a>	<a href="#">8X</a>	<a href="#">View</a>
King	<a href="#">Power Equipment Operators-Underground Sewer &amp; Water</a>	Hydralifts/boom trucks: 10 tons and under	\$75.55	<a href="#">7A</a>	<a href="#">11H</a>	<a href="#">8X</a>	<a href="#">View</a>
King	<a href="#">Power Equipment Operators-Underground Sewer &amp; Water</a>	Hydralifts/boom trucks: over 10 tons	\$79.00	<a href="#">7A</a>	<a href="#">11H</a>	<a href="#">8X</a>	<a href="#">View</a>
King	<a href="#">Power Equipment Operators-Underground Sewer &amp; Water</a>	Leverman	\$81.75	<a href="#">15J</a>	<a href="#">11G</a>	<a href="#">8X</a>	<a href="#">View</a>
King	<a href="#">Power Equipment Operators-Underground Sewer &amp; Water</a>	Loader, Overhead, 6 Yards. But Not Including 8 Yards	\$80.12	<a href="#">15J</a>	<a href="#">11G</a>	<a href="#">8X</a>	<a href="#">View</a>
King	<a href="#">Power Equipment Operators-Underground Sewer &amp; Water</a>	Loaders, Overhead Under 6 Yards	\$79.41	<a href="#">15J</a>	<a href="#">11G</a>	<a href="#">8X</a>	<a href="#">View</a>
King	<a href="#">Power Equipment Operators-Underground Sewer &amp; Water</a>	Loaders, Plant Feed	\$79.41	<a href="#">15J</a>	<a href="#">11G</a>	<a href="#">8X</a>	<a href="#">View</a>
King	<a href="#">Power Equipment Operators-Underground Sewer &amp; Water</a>	Loaders: Elevating Type Belt	\$78.80	<a href="#">15J</a>	<a href="#">11G</a>	<a href="#">8X</a>	<a href="#">View</a>
King	<a href="#">Power Equipment Operators-Underground Sewer &amp; Water</a>	Locomotives, All	\$79.41	<a href="#">15J</a>	<a href="#">11G</a>	<a href="#">8X</a>	<a href="#">View</a>
King	<a href="#">Power Equipment Operators-Underground Sewer &amp; Water</a>	Material Transfer Device	\$79.41	<a href="#">15J</a>	<a href="#">11G</a>	<a href="#">8X</a>	<a href="#">View</a>

King	<a href="#">Power Equipment Operators-Underground Sewer &amp; Water</a>	Mechanics: All (Leadmen - \$0.50 per hour over mechanic)	\$80.92	<a href="#">15J</a>	<a href="#">11G</a>	<a href="#">8X</a>	<a href="#">View</a>
King	<a href="#">Power Equipment Operators-Underground Sewer &amp; Water</a>	Motor Patrol Graders	\$80.12	<a href="#">15J</a>	<a href="#">11G</a>	<a href="#">8X</a>	<a href="#">View</a>
King	<a href="#">Power Equipment Operators-Underground Sewer &amp; Water</a>	Mucking Machine, Mole, Tunnel Drill, Boring, Road Header And/or Shield	\$80.12	<a href="#">15J</a>	<a href="#">11G</a>	<a href="#">8X</a>	<a href="#">View</a>
King	<a href="#">Power Equipment Operators-Underground Sewer &amp; Water</a>	Oil Distributors, Blower Distribution & Mulch Seeding Operator	\$75.35	<a href="#">15J</a>	<a href="#">11G</a>	<a href="#">8X</a>	<a href="#">View</a>
King	<a href="#">Power Equipment Operators-Underground Sewer &amp; Water</a>	Outside Hoists (Elevators and Manlifts), Air Tuggers, Strato	\$78.80	<a href="#">15J</a>	<a href="#">11G</a>	<a href="#">8X</a>	<a href="#">View</a>
King	<a href="#">Power Equipment Operators-Underground Sewer &amp; Water</a>	Overhead, bridge type Crane: 20 tons through 44 tons	\$79.62	<a href="#">7A</a>	<a href="#">11H</a>	<a href="#">8X</a>	<a href="#">View</a>
King	<a href="#">Power Equipment Operators-Underground Sewer &amp; Water</a>	Overhead, bridge type: 100 tons and over	\$81.12	<a href="#">7A</a>	<a href="#">11H</a>	<a href="#">8X</a>	<a href="#">View</a>
King	<a href="#">Power Equipment Operators-Underground Sewer &amp; Water</a>	Overhead, bridge type: 45 tons through 99 tons	\$80.33	<a href="#">7A</a>	<a href="#">11H</a>	<a href="#">8X</a>	<a href="#">View</a>
King	<a href="#">Power Equipment Operators-Underground Sewer &amp; Water</a>	Pavement Breaker	\$75.35	<a href="#">15J</a>	<a href="#">11G</a>	<a href="#">8X</a>	<a href="#">View</a>
King	<a href="#">Power Equipment Operators-Underground Sewer &amp; Water</a>	Pile Driver (other Than Crane Mount)	\$79.41	<a href="#">15J</a>	<a href="#">11G</a>	<a href="#">8X</a>	<a href="#">View</a>
King	<a href="#">Power Equipment Operators-Underground Sewer &amp; Water</a>	Plant Oiler - Asphalt, Crusher	\$78.80	<a href="#">15J</a>	<a href="#">11G</a>	<a href="#">8X</a>	<a href="#">View</a>
King	<a href="#">Power Equipment Operators-Underground Sewer &amp; Water</a>	Posthole Digger, Mechanical	\$75.35	<a href="#">15J</a>	<a href="#">11G</a>	<a href="#">8X</a>	<a href="#">View</a>
King	<a href="#">Power Equipment Operators-Underground Sewer &amp; Water</a>	Power Plant	\$75.35	<a href="#">15J</a>	<a href="#">11G</a>	<a href="#">8X</a>	<a href="#">View</a>
King	<a href="#">Power Equipment Operators-Underground Sewer &amp; Water</a>	Pumps - Water	\$75.35	<a href="#">15J</a>	<a href="#">11G</a>	<a href="#">8X</a>	<a href="#">View</a>
King	<a href="#">Power Equipment Operators-Underground Sewer &amp; Water</a>	Quad 9, Hd 41, D10 And Over	\$80.12	<a href="#">15J</a>	<a href="#">11G</a>	<a href="#">8X</a>	<a href="#">View</a>
King	<a href="#">Power Equipment Operators-Underground Sewer &amp; Water</a>	Quick Tower: no cab, under 100 feet in height base to boom	\$79.41	<a href="#">15J</a>	<a href="#">11G</a>	<a href="#">8X</a>	<a href="#">View</a>
King	<a href="#">Power Equipment Operators-Underground Sewer &amp; Water</a>	Remote Control Operator On Rubber Tired Earth Moving Equipment	\$80.12	<a href="#">15J</a>	<a href="#">11G</a>	<a href="#">8X</a>	<a href="#">View</a>
King	<a href="#">Power Equipment Operators-Underground Sewer &amp; Water</a>	Rigger and Bellman	\$75.55	<a href="#">7A</a>	<a href="#">11H</a>	<a href="#">8X</a>	<a href="#">View</a>
King	<a href="#">Power Equipment Operators-Underground Sewer &amp; Water</a>	Rigger/Signal Person, Bellman(Certified)	\$79.00	<a href="#">7A</a>	<a href="#">11H</a>	<a href="#">8X</a>	<a href="#">View</a>
King	<a href="#">Power Equipment Operators-Underground Sewer &amp; Water</a>	Rollagon	\$80.12	<a href="#">15J</a>	<a href="#">11G</a>	<a href="#">8X</a>	<a href="#">View</a>
King	<a href="#">Power Equipment Operators-Underground Sewer &amp; Water</a>	Roller, Other Than Plant Mix	\$75.35	<a href="#">15J</a>	<a href="#">11G</a>	<a href="#">8X</a>	<a href="#">View</a>
King	<a href="#">Power Equipment Operators-Underground Sewer &amp; Water</a>	Roller, Plant Mix Or Multi-lift Materials	\$78.80	<a href="#">15J</a>	<a href="#">11G</a>	<a href="#">8X</a>	<a href="#">View</a>
King	<a href="#">Power Equipment Operators-Underground Sewer &amp; Water</a>	Roto-mill, Roto-grinder	\$79.41	<a href="#">15J</a>	<a href="#">11G</a>	<a href="#">8X</a>	<a href="#">View</a>
King	<a href="#">Power Equipment Operators-Underground Sewer &amp; Water</a>	Saws - Concrete	\$78.80	<a href="#">15J</a>	<a href="#">11G</a>	<a href="#">8X</a>	<a href="#">View</a>
King	<a href="#">Power Equipment Operators-Underground Sewer &amp; Water</a>	Scraper, Self Propelled Under 45 Yards	\$79.41	<a href="#">15J</a>	<a href="#">11G</a>	<a href="#">8X</a>	<a href="#">View</a>

King	<a href="#">Power Equipment Operators-Underground Sewer &amp; Water</a>	Scrapers - Concrete & Carry All	\$78.80	<a href="#">15J</a>	<a href="#">11G</a>	<a href="#">8X</a>	<a href="#">View</a>
King	<a href="#">Power Equipment Operators-Underground Sewer &amp; Water</a>	Scrapers, Self-propelled: 45 Yards And Over	\$80.12	<a href="#">15J</a>	<a href="#">11G</a>	<a href="#">8X</a>	<a href="#">View</a>
King	<a href="#">Power Equipment Operators-Underground Sewer &amp; Water</a>	Shotcrete/Gunite Equipment	\$75.35	<a href="#">15J</a>	<a href="#">11G</a>	<a href="#">8X</a>	<a href="#">View</a>
King	<a href="#">Power Equipment Operators-Underground Sewer &amp; Water</a>	Shovel, Excavator, Backhoe, Tractors Under 15 Metric Tons	\$78.80	<a href="#">15J</a>	<a href="#">11G</a>	<a href="#">8X</a>	<a href="#">View</a>
King	<a href="#">Power Equipment Operators-Underground Sewer &amp; Water</a>	Shovel, Excavator, Backhoe: Over 30 Metric Tons To 50 Metric Tons	\$80.12	<a href="#">15J</a>	<a href="#">11G</a>	<a href="#">8X</a>	<a href="#">View</a>
King	<a href="#">Power Equipment Operators-Underground Sewer &amp; Water</a>	Shovel, Excavator, Backhoes, Tractors: 15 To 30 Metric Tons	\$79.41	<a href="#">15J</a>	<a href="#">11G</a>	<a href="#">8X</a>	<a href="#">View</a>
King	<a href="#">Power Equipment Operators-Underground Sewer &amp; Water</a>	Shovel, Excavator, Backhoes: Over 50 Metric Tons To 90 Metric Tons	\$80.92	<a href="#">15J</a>	<a href="#">11G</a>	<a href="#">8X</a>	<a href="#">View</a>
King	<a href="#">Power Equipment Operators-Underground Sewer &amp; Water</a>	Shovel, Excavator, Backhoes: Over 90 Metric Tons	\$81.75	<a href="#">15J</a>	<a href="#">11G</a>	<a href="#">8X</a>	<a href="#">View</a>
King	<a href="#">Power Equipment Operators-Underground Sewer &amp; Water</a>	Slipform Pavers	\$80.12	<a href="#">15J</a>	<a href="#">11G</a>	<a href="#">8X</a>	<a href="#">View</a>
King	<a href="#">Power Equipment Operators-Underground Sewer &amp; Water</a>	Spreader, Topsider & Screedman	\$80.12	<a href="#">15J</a>	<a href="#">11G</a>	<a href="#">8X</a>	<a href="#">View</a>
King	<a href="#">Power Equipment Operators-Underground Sewer &amp; Water</a>	Subgrader Trimmer	\$79.41	<a href="#">15J</a>	<a href="#">11G</a>	<a href="#">8X</a>	<a href="#">View</a>
King	<a href="#">Power Equipment Operators-Underground Sewer &amp; Water</a>	Tower Bucket Elevators	\$78.80	<a href="#">15J</a>	<a href="#">11G</a>	<a href="#">8X</a>	<a href="#">View</a>
King	<a href="#">Power Equipment Operators-Underground Sewer &amp; Water</a>	Tower Crane: over 175' through 250' in height, base to boom	\$81.97	<a href="#">7A</a>	<a href="#">11H</a>	<a href="#">8X</a>	<a href="#">View</a>
King	<a href="#">Power Equipment Operators-Underground Sewer &amp; Water</a>	Tower crane: up to 175' in height base to boom	\$81.12	<a href="#">7A</a>	<a href="#">11H</a>	<a href="#">8X</a>	<a href="#">View</a>
King	<a href="#">Power Equipment Operators-Underground Sewer &amp; Water</a>	Tower Cranes: over 250' in height from base to boom	\$82.76	<a href="#">7A</a>	<a href="#">11H</a>	<a href="#">8X</a>	<a href="#">View</a>
King	<a href="#">Power Equipment Operators-Underground Sewer &amp; Water</a>	Transporters, All Track Or Truck Type	\$80.12	<a href="#">15J</a>	<a href="#">11G</a>	<a href="#">8X</a>	<a href="#">View</a>
King	<a href="#">Power Equipment Operators-Underground Sewer &amp; Water</a>	Trenching Machines	\$78.80	<a href="#">15J</a>	<a href="#">11G</a>	<a href="#">8X</a>	<a href="#">View</a>
King	<a href="#">Power Equipment Operators-Underground Sewer &amp; Water</a>	Truck Crane Oiler/Driver: 100 tons and over	\$79.62	<a href="#">7A</a>	<a href="#">11H</a>	<a href="#">8X</a>	<a href="#">View</a>
King	<a href="#">Power Equipment Operators-Underground Sewer &amp; Water</a>	Truck Crane Oiler/Driver: 100 tons and over	\$79.62	<a href="#">7A</a>	<a href="#">11H</a>	<a href="#">8X</a>	<a href="#">View</a>
King	<a href="#">Power Equipment Operators-Underground Sewer &amp; Water</a>	Truck crane oiler/driver: under 100 tons	\$79.00	<a href="#">7A</a>	<a href="#">11H</a>	<a href="#">8X</a>	<a href="#">View</a>
King	<a href="#">Power Equipment Operators-Underground Sewer &amp; Water</a>	Truck Mount Portable Conveyor	\$79.41	<a href="#">15J</a>	<a href="#">11G</a>	<a href="#">8X</a>	<a href="#">View</a>
King	<a href="#">Power Equipment Operators-Underground Sewer &amp; Water</a>	Vac Truck (Vactor Guzzler, Hydro Excavator)	\$79.41	<a href="#">15J</a>	<a href="#">11G</a>	<a href="#">8X</a>	<a href="#">View</a>
King	<a href="#">Power Equipment Operators-Underground Sewer &amp; Water</a>	Welder	\$80.12	<a href="#">15J</a>	<a href="#">11G</a>	<a href="#">8X</a>	<a href="#">View</a>
King	<a href="#">Power Equipment Operators-Underground Sewer &amp; Water</a>	Wheel Tractors, Farmall Type	\$75.35	<a href="#">15J</a>	<a href="#">11G</a>	<a href="#">8X</a>	<a href="#">View</a>
King	<a href="#">Power Equipment Operators-Underground Sewer &amp; Water</a>	Yo Yo Pay Dozer	\$79.41	<a href="#">15J</a>	<a href="#">11G</a>	<a href="#">8X</a>	<a href="#">View</a>
King	<a href="#">Truck Drivers</a>	Asphalt Mix Over 16 Yards	\$72.45	<a href="#">15J</a>	<a href="#">11M</a>	<a href="#">8L</a>	<a href="#">View</a>



King	<a href="#">Truck Drivers</a>	Asphalt Mix To 16 Yards	\$71.61	<a href="#">15J</a>	<a href="#">11M</a>	<a href="#">8L</a>	<a href="#">View</a>
King	<a href="#">Truck Drivers</a>	Dump Truck	\$71.61	<a href="#">15J</a>	<a href="#">11M</a>	<a href="#">8L</a>	<a href="#">View</a>
King	<a href="#">Truck Drivers</a>	Dump Truck & Trailer	\$72.45	<a href="#">15J</a>	<a href="#">11M</a>	<a href="#">8L</a>	<a href="#">View</a>
King	<a href="#">Truck Drivers</a>	Other Trucks	\$72.45	<a href="#">15J</a>	<a href="#">11M</a>	<a href="#">8L</a>	<a href="#">View</a>

---

---

***APPENDIX B***  
***EXISTING UTILITY INFORMATION***

---

---

## Omar Barron

---

**From:** Brian Asbury <BASbury@lakehaven.org>  
**Sent:** Tuesday, December 13, 2022 10:10 AM  
**To:** Omar Barron  
**Subject:** RE: Old Target Bldg As Builts  
**Attachments:** 16562.pdf; wtr0618.pdf; s1090.pdf; ServConn App-2022B.pdf

### [EXTERNAL EMAIL WARNING]

This email originated from outside of the City of Federal Way and may not be trustworthy. Please use caution when clicking links, opening attachments, or replying to requests for information. If you have any doubts about the validity of this email please contact IT Help Desk at **x2555**.

Omar,

I've attached a GIS map image below, along with sewer service connection record 16562 that shows the sewer service connection. I've also attached water record drawing W-618 and sewer record drawing S-1090 for your reference/information.

The cut-n-cap of the sewer service connection does require a LWSD permit, I've attached that application form for your use. 2022 cost for this disconnect permit would be \$441.78; 2023 cost will be \$571.08.

Technically if working within 5' of the existing sewer main or manhole that'd be within LWSD's 10' wide sewer easement, and work in LWSD easement technically requires use of a LWSD-authorized sewer service contractor. Because this is City property, we'd waive this typical requirement for the City, so any contractor selected by the City would be allowed to perform this simple disconnect work. However, it could be best/easiest to simply have the existing manhole sewer service inlet penetration plugged & mortared in to perform this "disconnect"; this way no actual excavation (or materials disposal for that matter) would be needed, and the line could be re-used in the future if that works out for future site development.

Regarding water service connections/meters, I don't see where any of the three (3) water service connections/meters (located off the southeastern side of the building, SN 24263 = 2" Domestic, SN 25266 = 2" Irrigation, and SN 24461 = 8" fire-protection line) have been disconnected or removed, at least not from water main to water meters. There's been no usage on any of the water services/meters for years, so my guess would be the water "supply" lines (meter-to-building) may've been disconnected at some point to prevent vandalism type use of onsite water supply. Our typical recommendation for any existing water service connection/meter where site development (or in this case demolition with re-development in the future) is occurring is the leave the existing service connections active & simply have the owner/applicant protect those during building construction. However, because these are relatively close to the building, it may be necessary (or advisable) to have those services fully removed. That won't be an insignificant cost, as to fully do that we'd have to remove those service line connections at the water main along the east side of 23rd Ave S, and including removing the 3 service lines in 23rd Ave S (two 2" lines and one 8" line). Very preliminary deposit estimate to have all of those removed...something in the \$20,000+ range perhaps. If suspension of base charge service billing is desired, each of those meters can be removed by LWSD: 2022 = \$150.85 (each); 2023 = \$same. If/when these could be re-used in the future, it'd be the same cost (adjusted for any annual increases of course) to re-install such meters.

And timing wise...currently, we indicate to allow for approximately 4-5 weeks from time application is submitted until we'd be fully prepared to accept payment and issue any permits. It's actually not taking that long when a complete application packet is submitted, however I'll stick with our current recommendation to be on the safe side. You will need to identify/select a sewer service contractor to have a complete application to submit.

I hope this is helpful. Let me know if there's other questions or if additional information is needed.

**Brian Asbury**  
**Development Engineering Supervisor**



*Lakehaven DE Email: [DE@Lakehaven.org](mailto:DE@Lakehaven.org)*

*[Lakehaven DE Website](#)*

NOTE: Lakehaven Water & Sewer District neither warrants nor guarantees the accuracy of any facility information shown. Facility locations and conditions are subject to field verification.

Reviewed to Conform to District Construction Records  
*Norman Walter 1-8-91*  
 INSPECTOR  
*R.G. Wilmore 1-10-91*  
 DISTRICT ENGINEER DATE  
 RSL 2-7-90

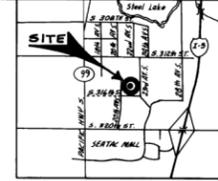

NOTE: THIS PROJECT SHALL BE CONSTRUCTED IN ACCORDANCE WITH FEDERAL WAY WATER DISTRICT STANDARD SPECIFICATIONS FOR WATER DISTRIBUTION SYSTEM EXTENSIONS APPROVED BY THE DEPARTMENT OF SOCIAL HEALTH SERVICES, ON OCT. 21, 1988.

LAKEWEN DOES NOT VERIFY, NOR IS RESPONSIBLE FOR THE ACCURACY OF THESE DRAWINGS.



NOTE: WEST VALVE REMOVED AND TEE BLIND FLANGED.

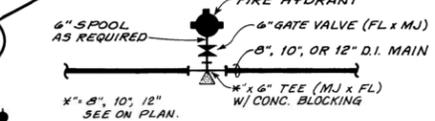
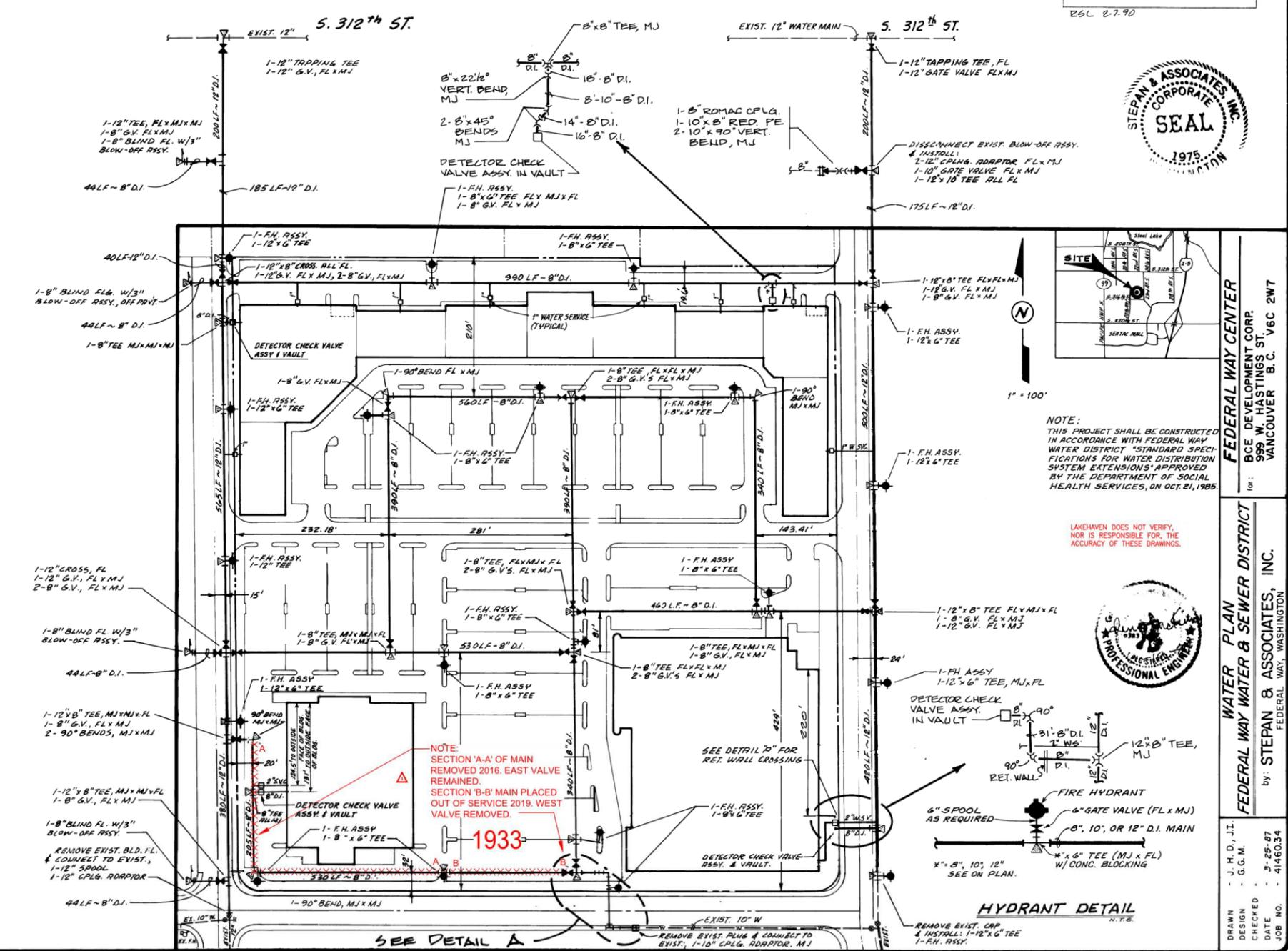
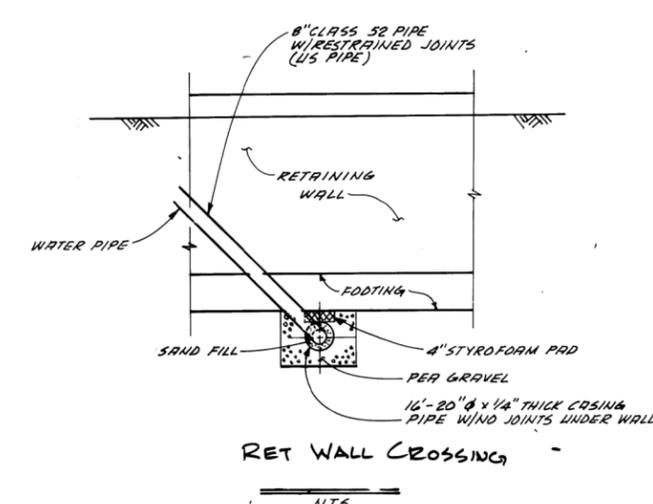
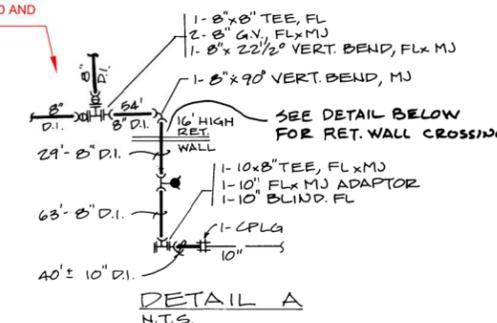

FEDERAL WAY CENTER  
 BCE DEVELOPMENT CORP.  
 995 W. HASTINGS ST.  
 VANCOUVER B.C. V6C 2W7

WATER PLAN  
 FEDERAL WAY WATER & SEWER DISTRICT  
 by: STEPAN & ASSOCIATES, INC.  
 FEDERAL WAY, WASHINGTON

103 C40

13

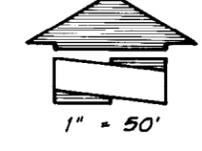
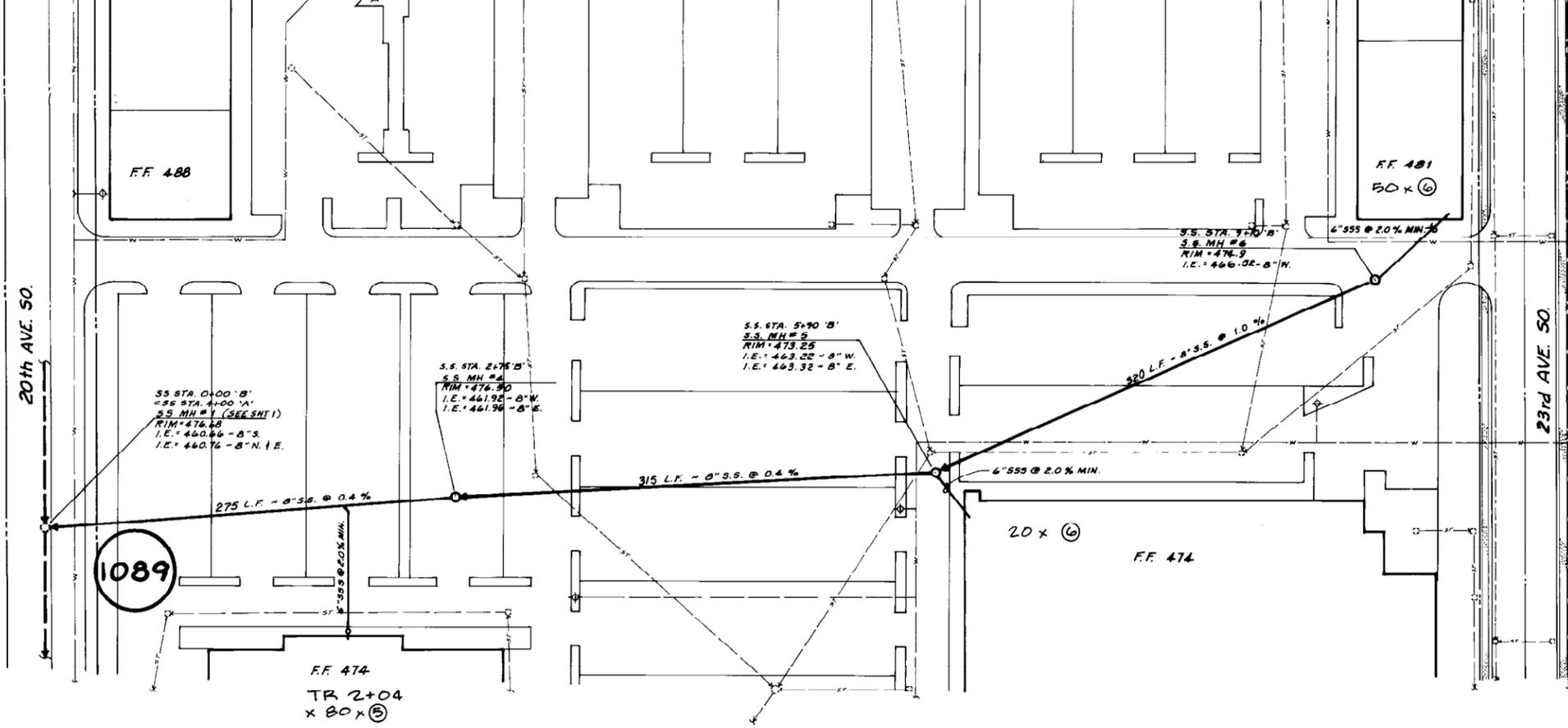

Federal Way Water and Sewer District  
STANDARD NOTES FOR SEWER CONSTRUCTION

- All elevations are based on King County Survey vertical datum.
- All work and materials shall conform to the "Standard Specifications for Municipal Public Works Construction," Washington State Chapter, APWA, 1981 edition, and to the standards of the Federal Way Water and Sewer District.
- Pipe material shall be PVC ASTM D3034 SDR 35, or F-789 or Ductile Iron ASTM A21.51.
- Manholes shall be Standard Plan No. 34 with eccentric cones, 1-inch drop safety steps, and 1 to 6 adjustment rings.
- Manhole covers shall be cast iron, with "SEWER" cast in top, weighting 140 to 150 pounds with single 1-inch lift hole fitted with 3/4" x 3 1/2" galvanized carriage bolt with burred end to restrain the nut.
- Manhole channels shall be smooth finish, no less than pipe O.D. and no more than 1/2 inch over pipe O.D.
- Manhole shelf shall be broom finish, sloped 1/2 to 1 inch per foot.
- No joint for flexible pipe shall be within 10 feet of the manhole and pipe shall be connected to manhole with asbestos cement collar.
- New mains connecting to existing facilities shall be sealed off until upstream construction is tested, cleaned and accepted. All construction debris and water shall be removed prior to opening the seal.
- Pipe ends shall not extend more than 2 inches inside manhole and all entrances shall be mudded around pipe.
- Trench shall be compacted prior to testing pipe and side sewers shall be tested at the same time as the main line.
- Side sewers shall be at least 2 percent grade, extending 8 feet inside property line and marked by white 2 x 4 post labeled "Sanitary Side Sewer."
- Contractor shall verify location of all utilities that may be affected by this work and shall notify appropriate utility companies to field-locate their facilities before contractor starts any excavation.
- Concrete collars reinforced with wire mesh per District standard construction detail shall be installed for all manholes not located in paved areas.
- Maximum finished floor differential shall be 4 feet for all structures served by a common side sewer.

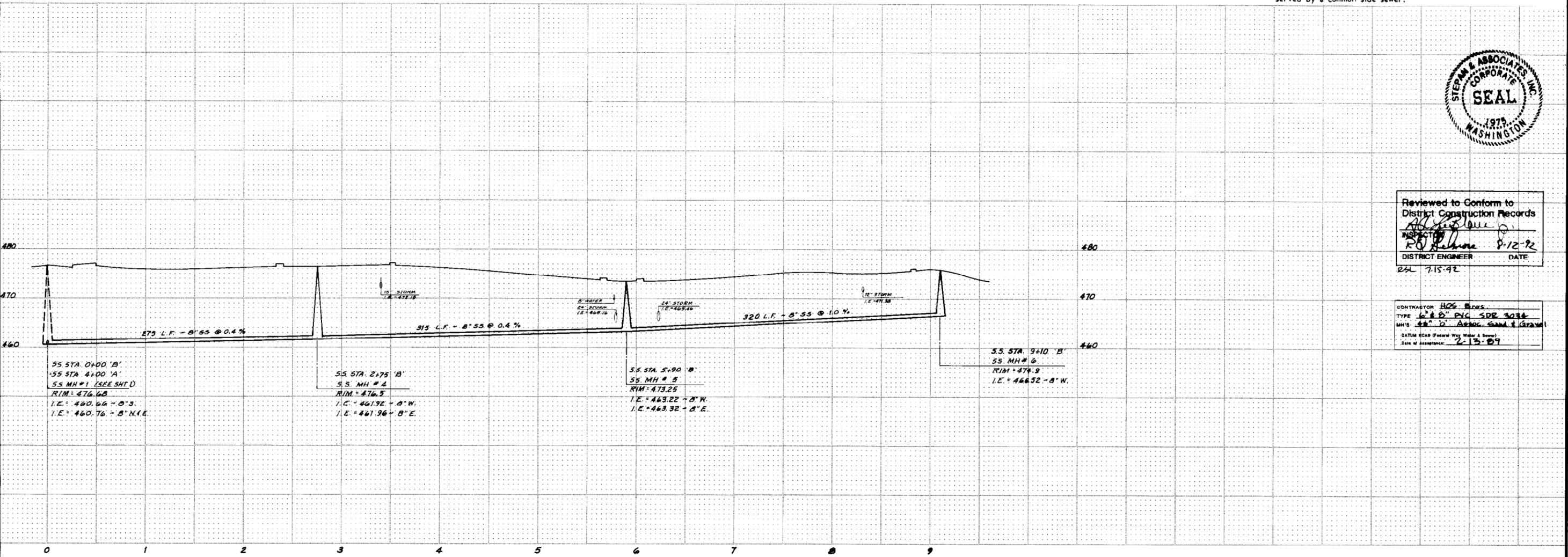

Reviewed to Conform to District Construction Records  
*Robert Bell*  
 DISTRICT ENGINEER  
 DATE 7.15.92

CONTRACTOR: HOC Eng.  
 TYPE: 6" D. PVC SDR 3034  
 MH'S: 48" D. ASSOC. SAND & GRAVEL  
 DATUM (Elev. Federal Way Water & Sewer)  
 Date of acceptance: 2-13-89

REVISIONS  
 DESIGN: G. G. M. CHECKED:  
 DRAWN: J. H. D. SCALE: BOX 1" = 50'



ENGINEERING & PLANNING & SURVEYING  
 33505 13TH PLACE S.O., SUITE B.  
 FEDERAL WAY, WASHINGTON 98003  
 TELEPHONE: TACOMA 922-7850  
 SEATTLE 682-4771

**Stepan & Associates**

HILLSIDE PLAZA  
 SANITARY SEWER  
 BCE DEVELOPMENT CORP.  
 999 W. HASTINGS ST. V6C 2W7  
 VANCOUVER, B.C.

For:  
 SHEET  
 2 OF 2  
 JOB NO.  
 41460.34

K-8

1090

# FEDERAL WAY WATER AND SEWER

PERMIT NUMBER **16562**

REPAIRS OR ALTERATIONS

\$100.00

## SIDE SEWER PERMIT

S/N.....  
 BOOK NO. 160/37  
 DWG NO. ....  
 DATE November 12, 1987

TOTAL PERMIT FEE.....

OWNER Target Store  
31501 20th Ave. South  
 PROPERTY ADDRESS .....  
 PLAT NAME Legal Attached to Application

SIDE SEWER CONTRACTOR St. Platz Mechanical  
Federal Way 98003  
 CITY ..... ZIP .....  
 LOT NO. .... BLK. NO. ....

SEE DE HILLSIDE PLAZA FOR SITE PLAN

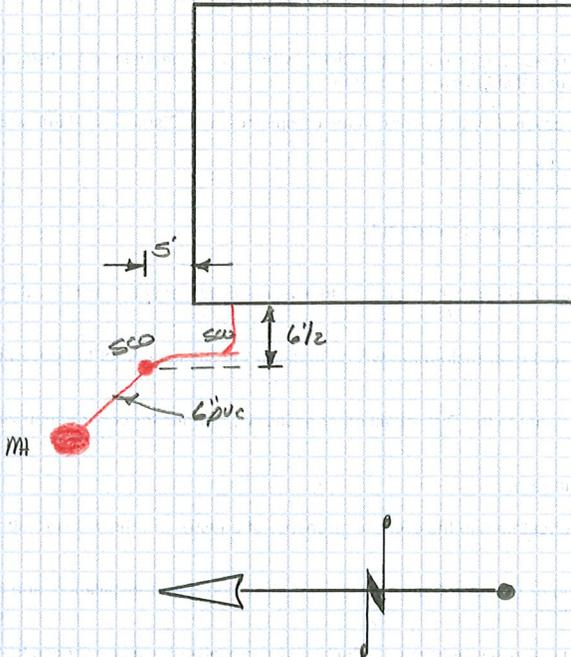

FEES	
App. Number	<u>1187-0827-2</u>
ULID/ULID Acc't #	<u>21</u>
IN LIEU OF ASSESSMENT	
Front Footage	\$ <u>N/A</u>
Other	\$ <u>N/A</u>
Developer Payback	\$ <u>N/A</u>
SUBTOTAL	\$ <u>N/A</u>
CONNECTION FEES	
ERU	\$ <u>21</u>
CFC/CIC	\$ <u>N/A</u>
AREA CHARGE	\$ <u>N/A</u>
PERMIT	\$ <u>100.00</u>
R-O-W	\$ _____
SUBTOTAL	\$ <u>100.00</u>
TOTAL	\$ <u>100.00</u>
Date Paid	<u>11/16/87</u>
Receipt No.	<u>56760</u>
BILLING TYPE:	
RESIDENTIAL	<input type="checkbox"/>
COMMERCIAL	<input checked="" type="checkbox"/>
Apt./Condo/M.H.	<input type="checkbox"/>
Public Auth.	<input type="checkbox"/>
DISTRICT	IN <input checked="" type="checkbox"/> OUT <input type="checkbox"/>
TREATMENT PLANT	<u>2</u>
LIFT STATION	<u>N/A</u>
ULID	<u>21</u>
¼ SECTION	<u>K-8</u>
BOOK	_____

PERMIT NUMBER **16562**

APPROVED BY [Signature] DATE 6-7-89 SCALE 1"=10'

I HEREBY CERTIFY THAT TESTING HAS BEEN APPROVED AND THE ABOVE CONNECTION HAS BEEN MADE AS SHOWN.

IN PLACE PIPE TEST:

TYPE TEST WATER EXFILTRATION  
 PERMIT FILE COPY

BY [Signature] DATE 11/23/87  
 INSPECTOR

RECEIVED

NOV 10 1987

FEDERAL WAY

WATER AND SEWER

31627 1ST AVENUE SOUTH (98003)
P.O. BOX 4249
FEDERAL WAY, WA 98063

1187-0827-2
040-16562
11/12/87

FEDERAL WAY WATER AND SEWER DISTRICT
SEATTLE 941-1516
BY MEC 11:15 AM

TACOMA 927-2922

APPLICATION FOR A SIDE SEWER PERMIT

PLOT/SITE PLAN IS REQUIRED FOR ALL APPLICATIONS

Setup 12-1-87

11-19

BN# 1100
AIC# 569-105.30
SIN 23463

TYPE OR PRINT LEGIBLY

OWNER TARGET Store PHONE (509) 839-5542

PROPERTY ADDRESS 31501 20th Ave So Federal Way 98003

BILLING ADDRESS John Pluhar (Target Stores) 3358 6th Minnie Minn 55440-1392

LEGAL DESCRIPTION: PLAT NAME See Attached LOT BLK

OTHER LEGAL DESCRIPTION

AUTHORIZED CONTRACTOR St Platz Mech 975 1st Avenue Issaquah PHONE 392 1237

BLDG. IDENTIFICATION N/A NO. OF UNITS PER BLDG. N/A

WAS BLDG. PREVIOUSLY CONNECTED? YES [ ] NO [X] IF YES, ACCOUNT #

RESIDENTIAL APT/CONDO/MOBILE HOME NON-RESIDENTIAL [X] WITHIN ULID 21

PROPERTY AREA 7.69 acres SQ. FT. (MULTIPLEX AND NON-RESIDENTIAL ONLY)

REGULATIONS AND REQUIREMENTS ARE SET FORTH ON REVERSE SIDE OF THIS APPLICATION

FOR DISTRICT USE ONLY

IN LIEU OF ASSESSMENT

FRONT FOOTAGE \$
OTHER FACILITIES \$
DEVELOPER PAYBACK \$
SUBTOTAL \$

CONNECTION FEES

NO. OF ERU 21
CFC/CIC \$
AREA CHARGE \$
BASIC PERMIT \$ 100.00
RIGHT OF WAY \$
PRETREATMENT \$
SUB TOTAL \$ 100.00
TOTAL \$ 100.00

BILLING TYPE

RESIDENTIAL [ ]
NON-RESIDENTIAL [X]
APT/CONDO/MH [ ]
PUB AUTH [ ]
DISTRICT IN [X] OUT [ ]
LIFT STATION N/A
ULID 21
TREATMENT PLANT LAKOTA
1/4 SEC K-8 BOOK

(allowable credit of 69 ERU)



CFC CALCULATION WORKSHEET

COMMERCIAL

TYPE RETAIL

SQUARE FOOTAGE OF STRUCTURE 105,350

÷ 1,000

= 105.35

CFC FACTOR X .2

ROUND TO NEAREST WHOLE # = 21

ULID - CREDIT (9 ERU/ACRE) - 69  
7.69 ACRE X 9 ERU

= Ø (1)

ERU (1) X \$ Ø = \$ Ø  
 CFC/CIC

COMMENTS/CONDITIONS:  
 \_\_\_\_\_  
 \_\_\_\_\_  
 \_\_\_\_\_  
 \_\_\_\_\_  
 \_\_\_\_\_  
 \_\_\_\_\_  
 \_\_\_\_\_  
 \_\_\_\_\_

MULTI-FAMILY

ACRES \_\_\_\_\_

X 10

(1) ROUND TO NEAREST WHOLE # = (1)  
 IF TOTAL UNITS - USE TOTAL UNITS

ULID - CREDIT (9 ERU/ACRE) - \_\_\_\_\_

= \_\_\_\_\_

67% of \$ \_\_\_\_\_ X \$ \_\_\_\_\_ (2)  
 CFC

IF TOTAL UNITS USED FOR \_\_\_\_\_ = \$ \_\_\_\_\_ (3)  
 (1) STOP HERE

TOTAL UNITS \_\_\_\_\_

- (1)

= \_\_\_\_\_

50% OF \$ \_\_\_\_\_ (2) X \$ \_\_\_\_\_

= \$ \_\_\_\_\_

+ \$ \_\_\_\_\_ (3)

TOTAL = \$ \_\_\_\_\_

\*THIS FORM TO BE ATTACHED TO ALL COMMERCIAL/MULTI-FAMILY PERMITS.

APPL./PERMIT NO. 16562

---

---

***APPENDIX C***  
***MISCELLANEOUS APPLICATIONS***

---

---



# PERMIT APPLICATION

PERMIT CENTER + 33325 8<sup>th</sup> Avenue South + Federal Way, WA 98003-6325  
 253-835-2607 + FAX 253-835-2609 + [permitcenter@cityoffederalway.com](mailto:permitcenter@cityoffederalway.com)

PERMIT NUMBER \_\_\_\_\_ - \_\_\_\_\_ - \_\_\_\_\_ - \_\_\_\_\_ - \_\_\_\_\_ - \_\_\_\_\_

TARGET DATE \_\_\_\_\_

SITE ADDRESS			SUITE/UNIT #		
PROJECT VALUATION \$	ZONING	ASSESSOR'S TAX/PARCEL # _____ - _____ - _____			
TYPE OF PERMIT	<input type="checkbox"/> BUILDING <input type="checkbox"/> PLUMBING <input type="checkbox"/> MECHANICAL <input type="checkbox"/> DEMOLITION <input type="checkbox"/> ENGINEERING <input type="checkbox"/> FIRE PREVENTION				
NAME OF PROJECT					
PROJECT DESCRIPTION <i>Detailed description of work to be included on this permit only</i>					
PROPERTY OWNER	NAME			PRIMARY PHONE	
	MAILING ADDRESS			E-MAIL	
	CITY	STATE	ZIP		
CONTRACTOR	NAME			PHONE	
	MAILING ADDRESS			E-MAIL	
	CITY	STATE	ZIP	FAX	
	WA STATE CONTRACTOR'S LICENSE #		EXPIRATION DATE / /	UBI #	
APPLICANT	NAME			PRIMARY PHONE	
	MAILING ADDRESS			E-MAIL	
	CITY	STATE	ZIP	FAX	
PROJECT CONTACT <i>(The individual to receive and respond to all correspondence concerning this application)</i>	NAME			PRIMARY PHONE	
	MAILING ADDRESS			E-MAIL	
	CITY	STATE	ZIP	FAX	
PROJECT FINANCING <i>When value is \$5,000 or more (RCW 19.27.095)</i>	NAME			<input type="checkbox"/> OWNER-FINANCED	
	MAILING ADDRESS, CITY, STATE, ZIP			PHONE	

**I certify under penalty of perjury that I am the property owner or authorized agent of the property owner. I certify that to the best of my knowledge, the information submitted in support of this permit application is true and correct. I certify that I will comply with all applicable City of Federal Way regulations pertaining to the work authorized by the issuance of a permit. I understand that the issuance of this permit does not remove the owner's responsibility for compliance with local, state, or federal laws regulating construction or environmental laws.**

**I further agree to hold harmless the City of Federal Way as to any claim (including costs, expenses, and attorneys' fees incurred in the investigation and defense of such claim), which may be made by any person, including the undersigned, and filed against the city, but only where such claim arises out of the reliance of the city, including its officers and employees, upon the accuracy of the information supplied to the city as a part of this application.**

SIGNATURE: \_\_\_\_\_ DATE \_\_\_\_\_

PRINT NAME: \_\_\_\_\_

<b>MECHANICAL PERMIT</b>	VALUE OF MECHANICAL WORK \$ _____																				
<i>Indicate <b>how many</b> of each type of fixture to be installed or relocated as part of this project. Do not include existing fixtures to remain.</i>																					
<table style="width:100%; border: none;"> <tr> <td style="width:33%;">_____ AIR HANDLING UNITS</td> <td style="width:33%;">_____ FANS</td> <td style="width:33%;">_____ GAS PIPE OUTLETS</td> <td style="width:33%;">_____ OTHER (Describe) _____</td> </tr> <tr> <td>_____ AIR CONDITIONER</td> <td>_____ FIREPLACE INSERTS</td> <td>_____ HOODS (Commercial)</td> <td>_____</td> </tr> <tr> <td>_____ BOILERS</td> <td>_____ FURNACES</td> <td>_____ HOT WATER TANKS (Gas)</td> <td>_____</td> </tr> <tr> <td>_____ COMPRESSORS</td> <td>_____ GAS LOG SETS</td> <td>_____ REFRIGERATION SYST</td> <td>_____</td> </tr> <tr> <td>_____ DUCTING</td> <td>_____ GAS PIPING</td> <td>_____ WOODSTOVES</td> <td>_____</td> </tr> </table>	_____ AIR HANDLING UNITS	_____ FANS	_____ GAS PIPE OUTLETS	_____ OTHER (Describe) _____	_____ AIR CONDITIONER	_____ FIREPLACE INSERTS	_____ HOODS (Commercial)	_____	_____ BOILERS	_____ FURNACES	_____ HOT WATER TANKS (Gas)	_____	_____ COMPRESSORS	_____ GAS LOG SETS	_____ REFRIGERATION SYST	_____	_____ DUCTING	_____ GAS PIPING	_____ WOODSTOVES	_____	
_____ AIR HANDLING UNITS	_____ FANS	_____ GAS PIPE OUTLETS	_____ OTHER (Describe) _____																		
_____ AIR CONDITIONER	_____ FIREPLACE INSERTS	_____ HOODS (Commercial)	_____																		
_____ BOILERS	_____ FURNACES	_____ HOT WATER TANKS (Gas)	_____																		
_____ COMPRESSORS	_____ GAS LOG SETS	_____ REFRIGERATION SYST	_____																		
_____ DUCTING	_____ GAS PIPING	_____ WOODSTOVES	_____																		

<b>PLUMBING PERMIT</b>	VALUE OF PLUMBING WORK \$ _____																				
<i>Indicate <b>how many</b> of each type of fixture to be installed or relocated as part of this project. Do not include existing fixtures to remain.</i>																					
<table style="width:100%; border: none;"> <tr> <td style="width:25%;">_____ BATHTUBS (or Tub/Shower Combo)</td> <td style="width:25%;">_____ LAVS (Hand Sinks)</td> <td style="width:25%;">_____ TOILETS</td> <td style="width:25%;">_____ WATER PIPING</td> </tr> <tr> <td>_____ DISHWASHERS</td> <td>_____ RAINWATER SYSTEMS</td> <td>_____ URINALS</td> <td>_____ OTHER (Describe) _____</td> </tr> <tr> <td>_____ DRAINS</td> <td>_____ SHOWERS</td> <td>_____ VACUUM BREAKERS</td> <td>_____</td> </tr> <tr> <td>_____ DRINKING FOUNTAINS</td> <td>_____ SINKS (Kitchen/Utility)</td> <td>_____ WATER HEATERS (Electric)</td> <td>_____</td> </tr> <tr> <td>_____ HOSE BIBBS</td> <td>_____ SUMPS</td> <td>_____ WASHING MACHINES</td> <td>_____ <b>TOTAL FIXTURES</b></td> </tr> </table>	_____ BATHTUBS (or Tub/Shower Combo)	_____ LAVS (Hand Sinks)	_____ TOILETS	_____ WATER PIPING	_____ DISHWASHERS	_____ RAINWATER SYSTEMS	_____ URINALS	_____ OTHER (Describe) _____	_____ DRAINS	_____ SHOWERS	_____ VACUUM BREAKERS	_____	_____ DRINKING FOUNTAINS	_____ SINKS (Kitchen/Utility)	_____ WATER HEATERS (Electric)	_____	_____ HOSE BIBBS	_____ SUMPS	_____ WASHING MACHINES	_____ <b>TOTAL FIXTURES</b>	
_____ BATHTUBS (or Tub/Shower Combo)	_____ LAVS (Hand Sinks)	_____ TOILETS	_____ WATER PIPING																		
_____ DISHWASHERS	_____ RAINWATER SYSTEMS	_____ URINALS	_____ OTHER (Describe) _____																		
_____ DRAINS	_____ SHOWERS	_____ VACUUM BREAKERS	_____																		
_____ DRINKING FOUNTAINS	_____ SINKS (Kitchen/Utility)	_____ WATER HEATERS (Electric)	_____																		
_____ HOSE BIBBS	_____ SUMPS	_____ WASHING MACHINES	_____ <b>TOTAL FIXTURES</b>																		

<b>GENERAL INFORMATION</b>			
CRITICAL AREAS ON PROPERTY?	WATER PURVEYOR	SEWER PURVEYOR	VALUE OF <u>EXISTING IMPROVEMENTS</u> \$ _____
EXISTING/PREVIOUS USE	LOT SIZE (In Square Feet)	EXISTING FIRE SPRINKLER SYSTEM? <input type="checkbox"/> Yes <input type="checkbox"/> No	PROPOSED FIRE SUPPRESSION SYSTEM? <input type="checkbox"/> Yes <input type="checkbox"/> No

<b>RESIDENTIAL - NEW OR ADDITION</b>				
AREA DESCRIPTION (in square feet)	EXISTING	PROPOSED	TOTAL	FOR OFFICE USE
BASEMENT				
FIRST FLOOR (or Mobile Home)				
SECOND FLOOR				
COVERED ENTRY				
DECK				
GARAGE <input type="checkbox"/> CARPORT <input type="checkbox"/>				
OTHER (describe)				
<b>Area Totals</b>	EXISTING	PROPOSED	TOTAL	
<b>**NEW HOMES ONLY**</b>				
ESTIMATED SELLING PRICE \$ _____			# OF BEDROOMS _____	

<b>COMMERCIAL – NEW/ADDITION</b>					
AREA DESCRIPTION	Area in Square Feet	Occupancy Group(s)	Construction Type	# of Stories	Additional Information
NEW BUILDING					
ADDITION					

<b>COMMERCIAL – REMODEL/TENANT IMPROVEMENTS</b>					
AREA DESCRIPTION	Area in Square Feet	Occupancy Group(s)	Construction Type	# of Stories	Additional Information
TOTAL BUILDING					
TENANT AREA ONLY					
PROJECT AREA ONLY					



DEMOLITION PERMIT REQUIREMENTS

A demolition permit is required to remove any structure on a subject property. Demolition of separate structures may require separate permits.

Address of Demolition: \_\_\_\_\_

Prior to submitting a demolition permit, the following items must be signed by the respective agency or their approvals attached. Items not applicable to your project should be marked N/A.

A completed Construction Permit Application form is also required.

1. ASBESTOS ABATEMENT

(Provide copy of Notice of Intent from Puget Sound Clean Air Agency and copy of inspection report by AHERA-certified inspector)

(City of Federal Way Building Official)

5. ELECTRICITY

(Puget Sound Energy/Tacoma Power)

2. FUEL STORAGE TANKS

- Under grade tank(s) is/are present
Above grade tank(s) are present
Tank(s) has been pumped or removed under South King Fire & Rescue permit prior to any dismantling or excavation

(South King Fire and Rescue)

6. NATURAL GAS

(Puget Sound Energy)

3. SEPTIC SYSTEM DECOMMISSIONING

(King County Environmental Services)

7. WATER - Public Source

(Lakehaven Water & Sewer District)

4. SANITARY SEWER

(Lakehaven Water & Sewer District)

8. WATER - Private Well

(King County Environmental Services)

Please Note: Erosion control measures must be in place during the demolition and through completion of the site clean-up.

(Applicant)



DEMOLITION PERMIT CONTACT LIST

This list of agencies may assist you in expediting the demolition permit process. Refer to the demolition permit requirements for signature blocks. All applicable signatures are required prior to permit approval.

- 1. Asbestos Removal: Puget Sound Clean Air Agency
2. Electricity: Puget Sound Energy and Tacoma Public Utilities
3. Gas: Puget Sound Energy
4. Telephone: Qwest Communications
5. Water: Lakehaven Water & Sewer District and Tacoma Public Utilities
6. Garbage: Waste Management
7. Sewer: Lakehaven Water & Sewer District
8. Septic: King County Environmental Services
9. Fire Department: South King Fire & Rescue

**LAKEHAVEN WATER & SEWER DISTRICT  
SERVICE CONNECTION APPLICATION**

Please type or print legibly. Yellow-shaded fields/information not required, please input information if known.

**All applications must be submitted with a Site Plan (required) and Private Utility Easements (if applicable)**

	<b>SEWER SERVICE CONNECTION</b>
	<b>WATER SERVICE CONNECTION / METER INSTALLATION</b>

^ Check One or Both Above

**PROPERTY & BUILDING INFORMATION**

Building/Property Address	Address					
	City			State		Zip
Tax Parcel No.				Property Area	square feet	
Plat / BSP / BLA				Recording #		
Lot #(s)				Block #(s)		

*Attach Legal Property Description to Service Connection Application Form on Separate Sheet*

Property Elevations (NAVD-88 datum)	High	Low	Source of Information
Finished Floor Elevations (NAVD 88 datum) <b>Req'd for daylight basement</b>	High	Low	Source of Information

Bldg. Area	square feet	# MFR Units	Business Type :
------------	-------------	-------------	-----------------

**PROPERTY OWNER INFORMATION**

Owner Name(s)				Owner Phone #		
Mailing Address	Address					
	City			State		Zip
Owner Email						
Contact Name				Phone #		Ext
Contact Email				Cell #		

**SERVICE HISTORY**

Previous Connection(s) to Water?	No <input type="checkbox"/>	Yes <input type="checkbox"/>	Service Number(s):
Previous Connection(s) to Sewer?	No <input type="checkbox"/>	Yes <input type="checkbox"/>	Service Number(s):

**SEWER SERVICE INFORMATION**

New-Full Bldg. Connection <input type="checkbox"/>		New-Stub Only <input type="checkbox"/>		Existing-Disconnect <input type="checkbox"/>	
Permanent <input type="checkbox"/>	Temporary (perm. service / temp. location) <input type="checkbox"/>		Short Term (e.g., project terms) <input type="checkbox"/>		
Classification	Single-Family Residential <input type="checkbox"/>		Multi-Family Residential <input type="checkbox"/>		Commercial/Non-res. <input type="checkbox"/>
	Accessory Dwelling Unit (ADU) <input type="checkbox"/>		Public Authority <input type="checkbox"/>		
Contractor				Phone #	
Contact				Phone #	
Email					

Grinder Pump (if applicable) <input type="checkbox"/>	Make	Model
---	------	-------

**WATER SERVICE INFORMATION**

New-Full w/meter <input type="checkbox"/>		New-Stub w/o meter <input type="checkbox"/>		Existing-Upsize <input type="checkbox"/>		Existing-Abandonment <input type="checkbox"/>	
Permanent <input type="checkbox"/>	Temporary (perm. service / temp. location) <input type="checkbox"/>			Short Term (e.g., project terms) <input type="checkbox"/>			
Classification	Single-Family Residential <input type="checkbox"/>		Multi-Family Residential <input type="checkbox"/>		Commercial/Non-res. <input type="checkbox"/>		
	Public Authority <input type="checkbox"/>		Accessory Dwelling Unit (ADU) <input type="checkbox"/>		Irrigation <input type="checkbox"/>	**Fire Protection <input type="checkbox"/>	

\*\*Fire system designer must email [DE@Lakehaven.org](mailto:DE@Lakehaven.org) with the following information:

Potable or Non-potable system; Max GPM; Recommended LWSD Service Line & Meter Size; and Recommended Supply Line Size

